

TX-W32D2DP Service Manual

Safety

Specifications

Parts List

Service
Information

Adjustments

Self Check

Service Hints

Mechanical
View

Disassembly

Location of
Controls

Waveforms

Block Diagrams

Schematic Diagrams

PCB Views

Service Support

Service and repair of this product is supported by Panasonic's LUCI interface.

This interface provides a link between the TV and a standard PC to allow a number of diagnostic and control functions to be performed.

For more details contact your local Panasonic company.

BACK

EXIT

B1 - PCB

C - PCB

D - PCB

E - PCB

F - PCB

G - PCB

H - PCB

J - PCB

K - PCB

M2 - PCB

Y - PCB



BACK

B1 - Schematic

C - Schematic

D - Schematic

E - Schematic

F - Schematic

G - Schematic

H - Schematic

J - Schematic

K - Schematic

M2 - Schematic

Y - Schematic



BACK

Video / Audio

Control

Dolby



BACK

Service Manual



Colour Television

TX-W32D2DP

EURO-3HW Chassis

Specifications

Power Source :	220 – 240 V AC, 50Hz	AV3 IN	S-Video IN Y : 1 Vp-p 75Ω (4-pin) C : 0.3 Vp-p 75Ω Audio (RCA x 2) 500 mV rms 10kΩ Video (RCA x 1) 1 Vp-p 75Ω
Power Consumption :	207W	AV4 IN	Video (21 pin) 1 Vp-p 75Ω Audio (21 pin) 500 mV rms 10kΩ
Aerial Impedance :	75Ω unbalanced, Coaxial Type	AV4 OUT	Video (21 pin) 1 Vp-p 75Ω Audio (21 pin) 500 mV rms 1kΩ
Receiving System :	PAL I PAL 60, M.NTSC, NTSC (AV Only)	High Voltage :	30.5 kV ± 1kV
Receiving Channels :	UHF E21 – E69	Picture Tube :	W76LFC185X05 76 cm 106° deflection
Intermediate Frequency :		Audio Output :	
Video	39.5MHz	Internal Speaker	2 x 20W (Front)(Music Power) 2 x 15W (Rear)
Sound	33.5MHz, 32.95MHz	(Music Power)	20W (Centre)(Music Power) 26W (3D Bass)(Music Power) 8 Ω Impedance
Colour	35.07MHz	Headphones	8 Ω Impedance
Video / Audio Terminals :		Accessories supplied :	Remote Control 2 x R6 (UM3) Batteries TS-400DP TV Stand/Speaker
DOLBY SURROUND OUT	Audio (RCA x 5) 500 mV rms 1kΩ	pack	
AV1 IN	Video (21 pin) 1 Vp-p 75Ω Audio (21 pin) 500 mV rms 10kΩ RGB (21 pin)	Dimensions :	Height : 555mm Width : 862mm Depth : 553mm
AV1 OUT	Video (21 pin) 1 Vp-p 75Ω Audio (21 pin) 500 mV rms 1kΩ	Net Weight :	52kg
AV2 IN	Video (21 pin) 1 Vp-p 75Ω Audio (21 pin) 500 mV rms 10kΩ S-Video IN Y : 1 Vp-p 75Ω (21 pin) C : 0.3 Vp-p 75Ω		
AV2 OUT	Video (21 pin) 1 Vp-p 75Ω Audio (21 pin) 500 mV rms 1kΩ Selectable output (21 pin)		

Specifications are subject to change without notice.
Weight and dimensions shown are approximate.

NOTE : This service manual should be used in conjunction with the EURO 3 and Dolby technical guides.

Panasonic CS (U.K.) Ltd.

WILLOUGHBY ROAD,
BRACKNELL, BERKS,
RG12 8FT.

CONTENTS

- SAFETY PRECAUTIONS
- LOCATION OF CONTROLS
- SERVICE HINTS
- SERVICE POSITION
- ADJUSTMENTS
- SELF CHECK
- WAVEFORM PATTERN TABLE
- CONDUCTOR VIEWS
- BLOCK DIAGRAM
- SCHEMATIC DIAGRAMS
- PARTS LOCATION
- REPLACEMENT PARTS LIST

SAFETY PRECAUTIONS

General Guide Lines

1. It is advisable to insert an isolation transformer in the AC supply before servicing a hot chassis.
2. When servicing, observe the original lead dress in the high voltage circuits. If a short circuit is found, replace all parts which have been overheated or damaged by the short circuit.
3. After servicing, see that all the protective devices such as insulation barriers, insulation papers, shields and isolation R-C combinations are correctly installed.
4. When the receiver is not being used for a long period of time, unplug the power cord from the AC outlet.
5. Potentials as high as 32kV are present when this receiver is in operation. Operation of the receiver without the rear cover involves the danger of a shock hazard from the receiver power supply. Servicing should not be attempted by anyone who is not familiar with the precautions necessary when working on high voltage equipment. Always discharge the anode of the picture to the chassis before handling the tube.
6. After servicing make the following leakage current checks to prevent the customer from being exposed to shock hazards.

LEAKAGE CURRENT COLD CHECK

1. Unplug the AC cord and connect a jumper between the two prongs of the plug.
2. Turn on the receiver's power switch.
3. Measure the resistance value with an ohmmeter, between the jumpered AC plug and each exposed metallic cabinet part on the receiver, such as screw heads, aerials, connectors, control shafts etc. When the exposed metallic part has a return path to the chassis the reading should be between 4M ohm and 20M ohm. When the exposed metal does not have a return path to the chassis the reading must be infinite.

LEAKAGE CURRENT HOT CHECK

1. Plug the AC cord directly into the AC outlet. Do not use an isolation transformer for this check.
2. Connect a 2kΩ 10W resistor in series with an exposed metallic part on the receiver and an earth such as a water pipe.
3. Use an AC voltmeter with high impedance to measure the potential across the resistor.

4. Check each exposed Metallic part and check the voltage at each point.
5. Reverse the AC plug at the outlet and repeat each of the above measurements.
6. The potential at any point should not exceed 1.4 Vrms. In case a measurement is outside the limits specified, there is a possibility of a shock hazard, and the receiver should be repaired and rechecked before it is returned to the customer.

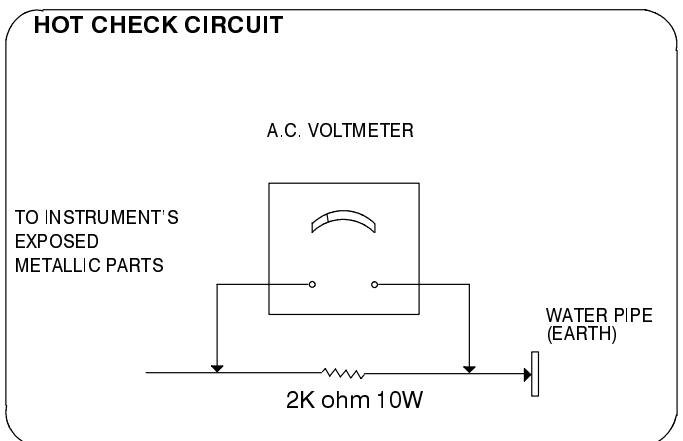

Fig.1

X-RADIATION WARNING

1. The potential sources of X-Radiation in TV sets are the high voltage section and the picture tube.
2. When using a picture tube test jig for service ensure that the jig is capable of handling 32kV without causing X-Radiation.

NOTE : It is important to use an accurate periodically calibrated high voltage meter.

1. Set the brightness to minimum.
2. Measure the high voltage. The meter should indicate 30.5kV ± 1kV if the meter indication is out of tolerance, immediate service and correction is required to prevent the possibility of premature component failure.
3. To prevent any X-Radiation possibility, it is essential to use the specified tube.

Location Of Controls

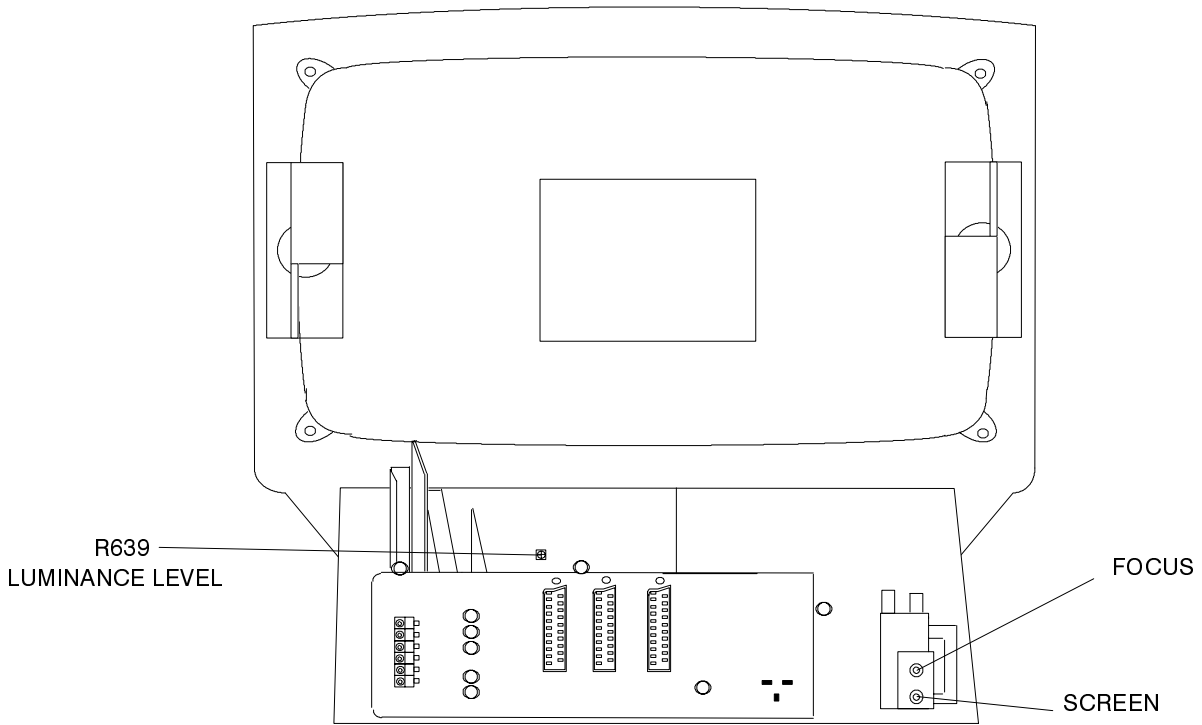

Fig.2

SERVICE HINTS

How to remove the rear cover

1. Remove the 10 screws (A) as shown in Fig.3/Fig.4.

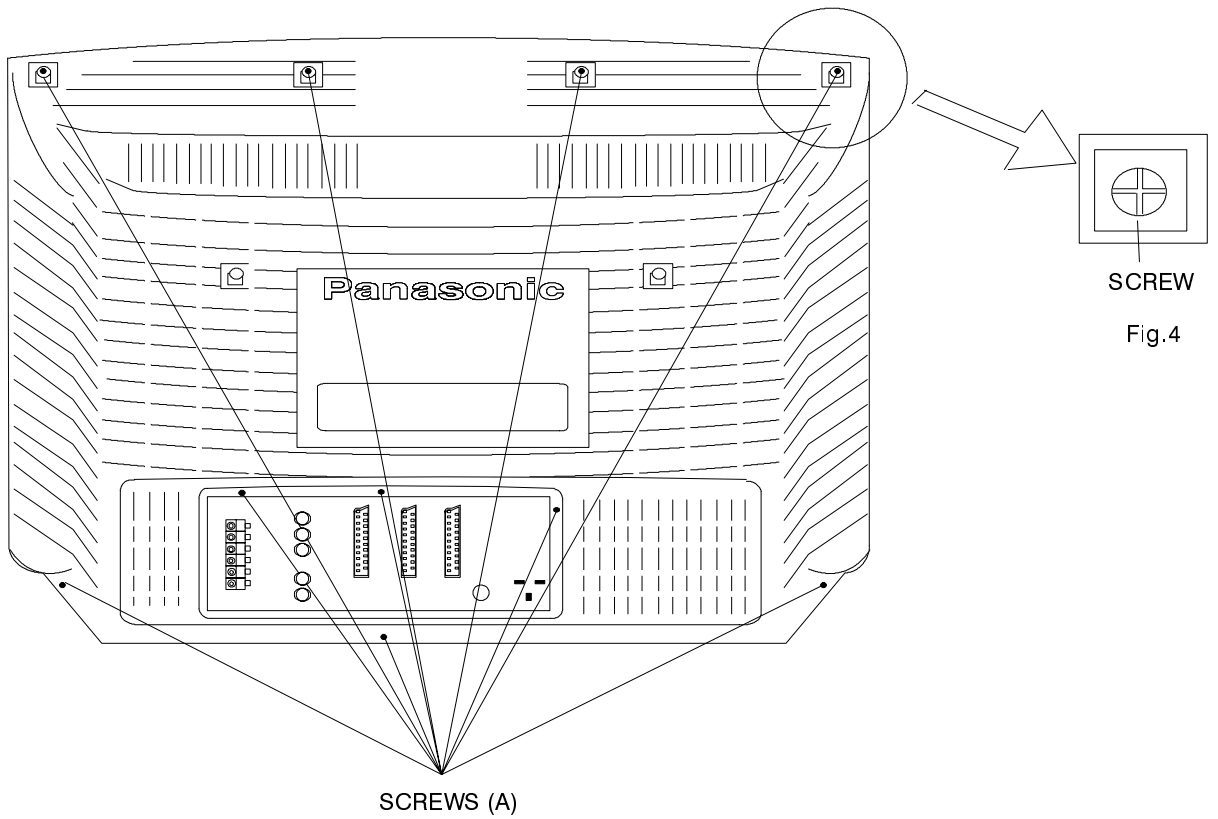

Fig.3.

How to move the chassis into the Service position

1. Hold and lift the rear of the E- PCB chassis and gently pull the chassis toward you.
2. Release the respective wiring clips and turn the chassis through 90°, anti-clockwise, as shown in Fig.6.
3. Clip the chassis onto the bead clammer shown in Fig.7.
4. Place the locating pin on the chassis frame into the location hole on the cabinet shown in Fig.8.
5. After servicing ensure all wiring is returned to its original position before returning the receiver to the customer.

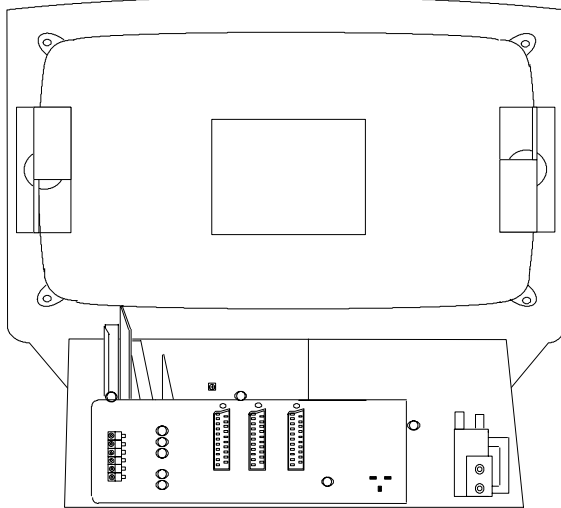

Fig.5

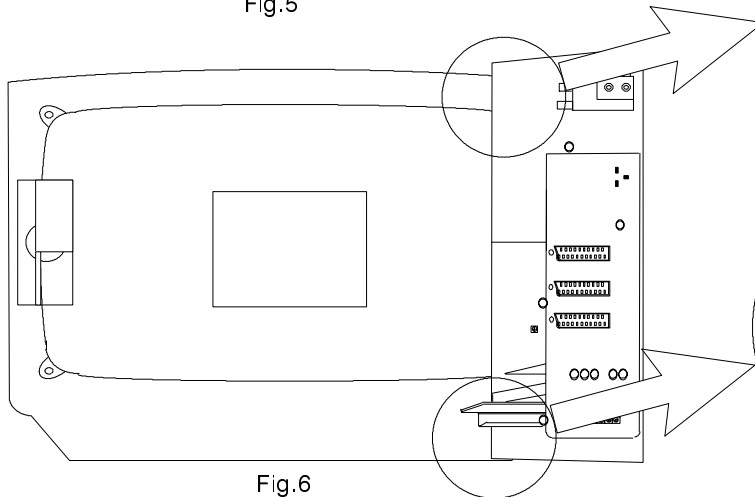

Fig.6

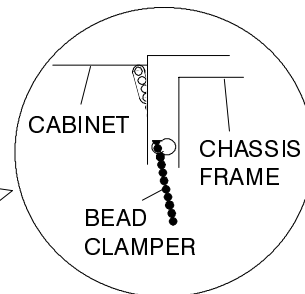

Fig.7

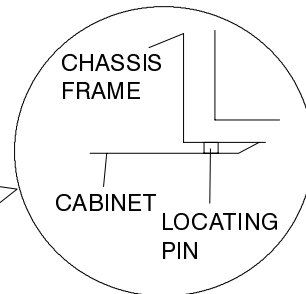

Fig.8

Service Position for the K-Board

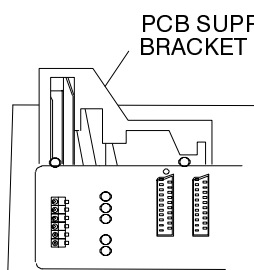
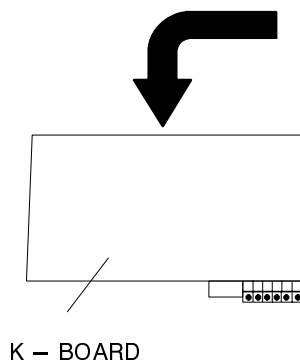

Fig.9



K - BOARD

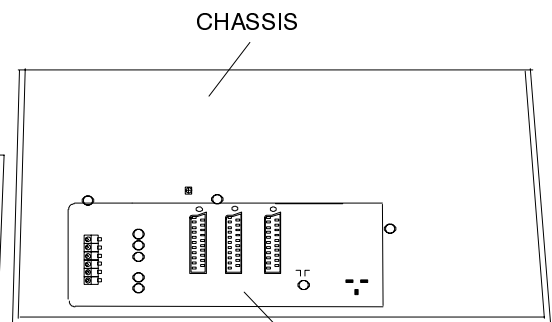

Fig.10

H-BOARD

1. Remove the two screws from the PCB support bracket and remove the bracket shown in Fig.9.
2. Unclip the K-Board and pull out making sure that the K-board does not touch the E-board.
3. Fit the extension leads
4. After servicing ensure all wiring is returned to its original position before returning the receiver to the customer.
NOTE : The extension lead wire kit is supplied as a service kit. (Part number TZS6EZ001).

Adjustment Procedure

The remote control is used for entering and storing adjustments, with the exception of cut-off adjustments which must always be done prior to service adjustment. Perform adjustments in accordance with screen display. The display on the screen also specifies the CCU variants as well as the approx. setting values. The adjustment sequence for the service mode is indicated below.

1. Set the Bass to maximum position, set the Treble to 3. minimum position, press and hold the Reveal button on the remote control and at the same time press the ---/v button on the customer controls at the front of the TV, this will place the TV into the Service Mode.
2. Press the RED / GREEN buttons to step up / down through the functions.
3. Press the YELLOW / BLUE buttons to alter the function values.
4. Press the STORE button after each adjustment has been made to store the required values.
5. To exit the Service Mode press the Normalisation button.

NOTE: This TV also has the option of using a Memory Pack which enables you to copy the preset TV channels into the Memory Pack and then download them onto this or any other EURO-3 TV set.

TV to Memory Pack process

1. Plug the memory pack into the AV2 21 pin terminal at the back of the TV and switch the TV on.
2. Go into the Service Mode as explained above. The screen will show:—

Program
External>>TV

3. Press the blue button on the remote control. The screen will show:—

Program
TV>>External

4. Press the STORE button on the TV. The screen will show:—

Storing

5. All the tuning information stored inside the TV will now be transferred to the Memory Pack. This process will take 2–3 minutes to complete and when finished the screen will show:—

OK!

1. Plug the memory pack into the AV2 21 pin terminal at the back of the TV and switch the TV on.

2. Go into the Service Mode as explained above. The screen will show:—

Program
External>>TV

3. Press the STORE button on the TV. The screen will show:—

Loading

4. All the tuning information stored inside the Memory Pack will now be transferred to the TV. This process will take 2–3 minutes to complete and when finished the screen will show:—

OK!

5. The tuning information from the Memory Pack has now been copied into the TV.

6. To exit from the Service Mode press the Normalisation button.

7. The process has now been completed and the Memory Pack can now be removed.

Memory Pack to TV Process

Errors

If an error occurs while using the Memory Pack the TV will detect this and the screen will show:—

Program
Error!

If this happens then press the Normalisation button and repeat the process that was being used. If the errors continue to occur then check the connectors between the TV and the memory pack and check the 9V battery inside the memory pack.

Alignment Settings

(The figures used below are nominal and used for representative purposes only)

Please Note

When aligning the TV, in Service Mode 1, please remember that separate alignments need to be performed in both PAL (50Hz) and NTSC (60Hz) systems for 4:3 , FULL and JUST aspect modes.

Alignment Function		Settings / Special features
Vertical amplitude	V-AMP 038	Optimum setting.
Vertical linearity	V-LIN 022	
V-Pos.	V-POS 005	Optimum setting.
Horizontal amplitude	H-AMP 043	Optimum setting.
Horizontal position	H-POS 035	
EW-amplitude	E/W-AMP 1 020	Optimum setting.
EW-amplitude	E/W-AMP 2 015	Optimum setting.
Trapezium-comp	TRAPEZ-1 004	Optimum setting.
Vert. DC.	VERT. D.C. 008	Not to be adjusted.
Text Position	TEXT POSITION 060	Optimum setting.
Cutoff	---	Select a Greyscale pattern enter Service Mode and step through to Cutoff, connect an oscilloscope to the Blue Cathode and adjust the screen VR of the FBT to get $150 \pm 5V$ at the base of the Cutoff pulse.
Cutoff RGB	CUTOFF RGB 032 032 032	Press the GREEN button to step through the settings. Adjust for optimum.
White RGB	WHITE RGB 032 032 032	Press the GREEN button to step through the settings. Adjust for optimum.
Sub Brightness	SUB BRIGHT 000	Optimum setting.

ADJUSTMENT PROCEDURE

Item/Preparation	Adjustments
Supply Voltage Check	1. Confirm the following voltages.
1. Receive a Greyscale pattern	E PCB
2. Set the controls:	D PCB
Brightness minimum	U5B 5 ± 0.5V U5A 5.1 ± 0.12/-0.1V
Contrast minimum	U8A 8 ± 0.5V U5SB 5 ± 0.25V
Volume minimum	U8B 8 ± 0.5V U15 15 ± 0.7V
	U9 9 ± 0.5V U16 16.1 ± 0.8V
	U12 11.8 ± 0.5V U22 22.5 ± 1V
	U38 19 ± 1V
	U47 47.5 ± 2.5V
	U150 150 ± 1V
	U200 204 ± 10V
	K PCB
	IC2502 PIN 3 +12 ± 0.5V
	IC2503 PIN 3 +5 ± 0.25V
	IC2508 PIN 3 +9 ± 0.3V
	L2503 NO LOAD +20 ± 1V
	L2513 NO LOAD -20 ± 1V

SELF CHECK

Self check is used to automatically check the Bus Lines and Hexadecimal code of the TV set. To get into the Self Check mode press the Status button on the Remote Control at the same time pressing the ---/v button on the customer controls at the front of the TV, and the screen will show:—



0 — ok	Test Byte	8 — ok	Col Decoder (M)	16 — ok	Col Decoder (P)
1 — ok	Lst Power	9 — ok	Clock generator	17 — ok	Q – PIP
2 — ok	U5 Det	10 — ok	V – Processor	18 — ok	Not Used
3 — ok	Protector	11 — ok	DFU	19 — ok	Not Used
4 — ok	Not Used	12 — ok	Display Processor	20 — ok	EAROM
5 — ok	Not Used	13 — ok	RGB Processor	21 — ok	Audio Matrix
6 — ok	Not Used	14 — ok	Deflection IC	22 — ok	Video Matrix
7 — ok	Not Used	15 — ok	MSP	23 — ok	Tuner

If the CCU ports have been checked and found to be incorrect or not located then "—" will appear in place of "OK".

Hex codes

40
70
FF
11
10
E8
04

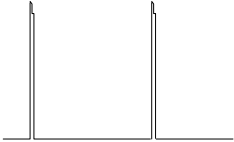
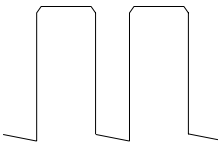
WAVEFORM PATTERN TABLE

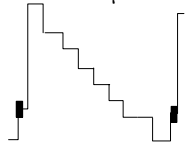
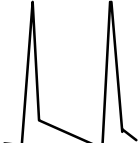
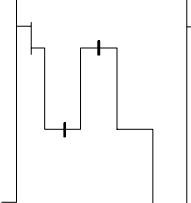
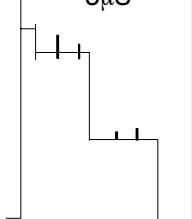
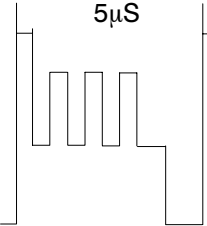
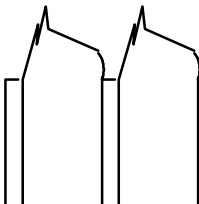
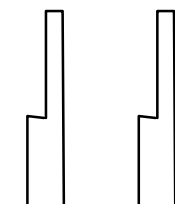
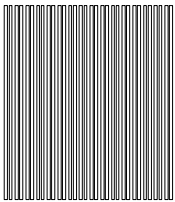
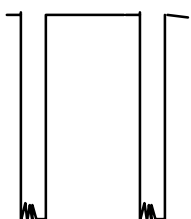
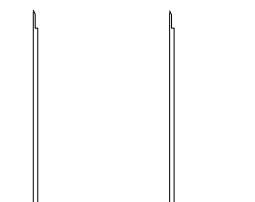
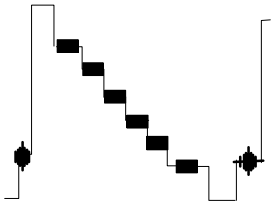
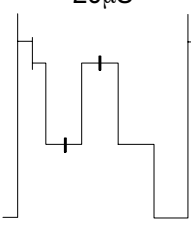
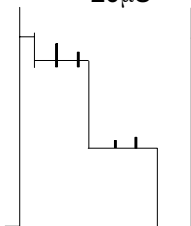
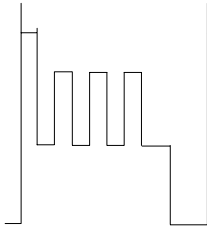
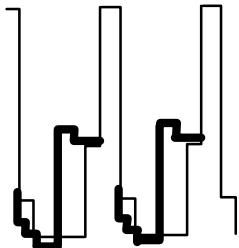
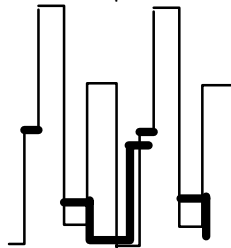
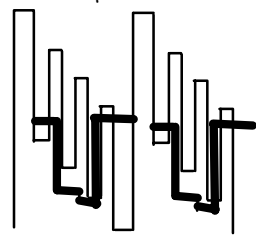
<p>IC 3501 PIN3 1μS</p> 	<p>IC 3501 PIN4 1μS</p> 	<p>IC601 PIN25 5μS</p> 	<p>IC601 PIN26 5μS</p> 
<p>Q552 COLLECTOR 20μS</p> 	<p>IC 603 PIN 20 5μS</p> 	<p>IC 603 PIN 24 5μS</p> 	<p>IC 603 PIN 22 5μS</p> 
<p>Q502 COLLECTOR 64μS</p> 	<p>IC 1801 PIN 10 20μS</p> 	<p>IC 1803 PIN 12 20μS</p> 	<p>IC 1803 PIN 1 20μS</p> 
<p>IC 1841 PIN 10 5μS</p> 	<p>IC 1801 PIN 26 5μS</p> 	<p>IC 371 PIN 3 20μS</p> 	<p>IC 351 PIN 3 20μS</p> 
<p>IC 361 PIN 3 20μS</p> 	<p>TPY1 5μS</p> 	<p>TPY2 5μS</p> 	<p>TPY3 5μS</p> 

VIDEO AND AUDIO SIGNAL PROCESSING BLOCK DIAGRAM

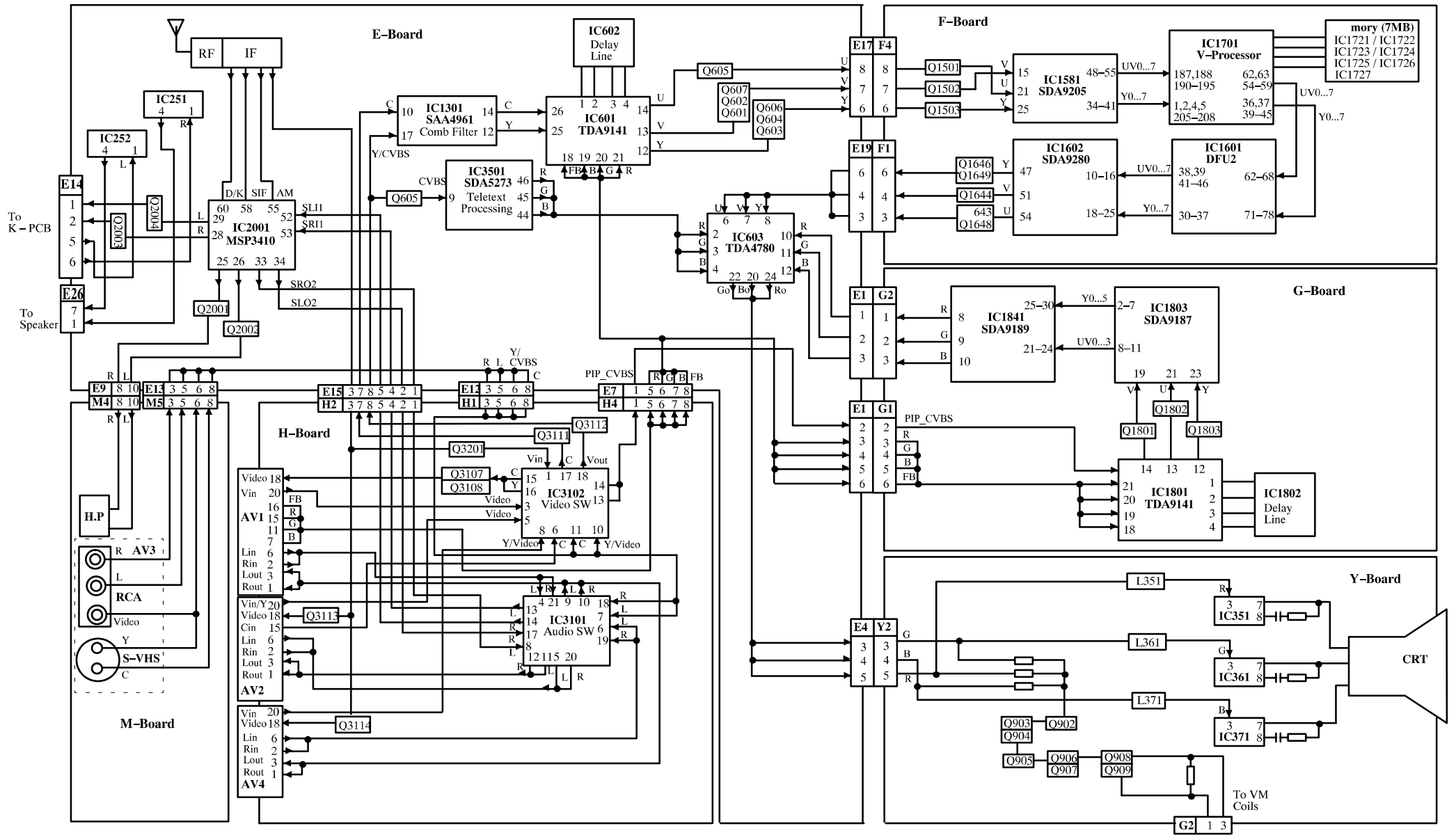

CONTROL BLOCK DIAGRAM

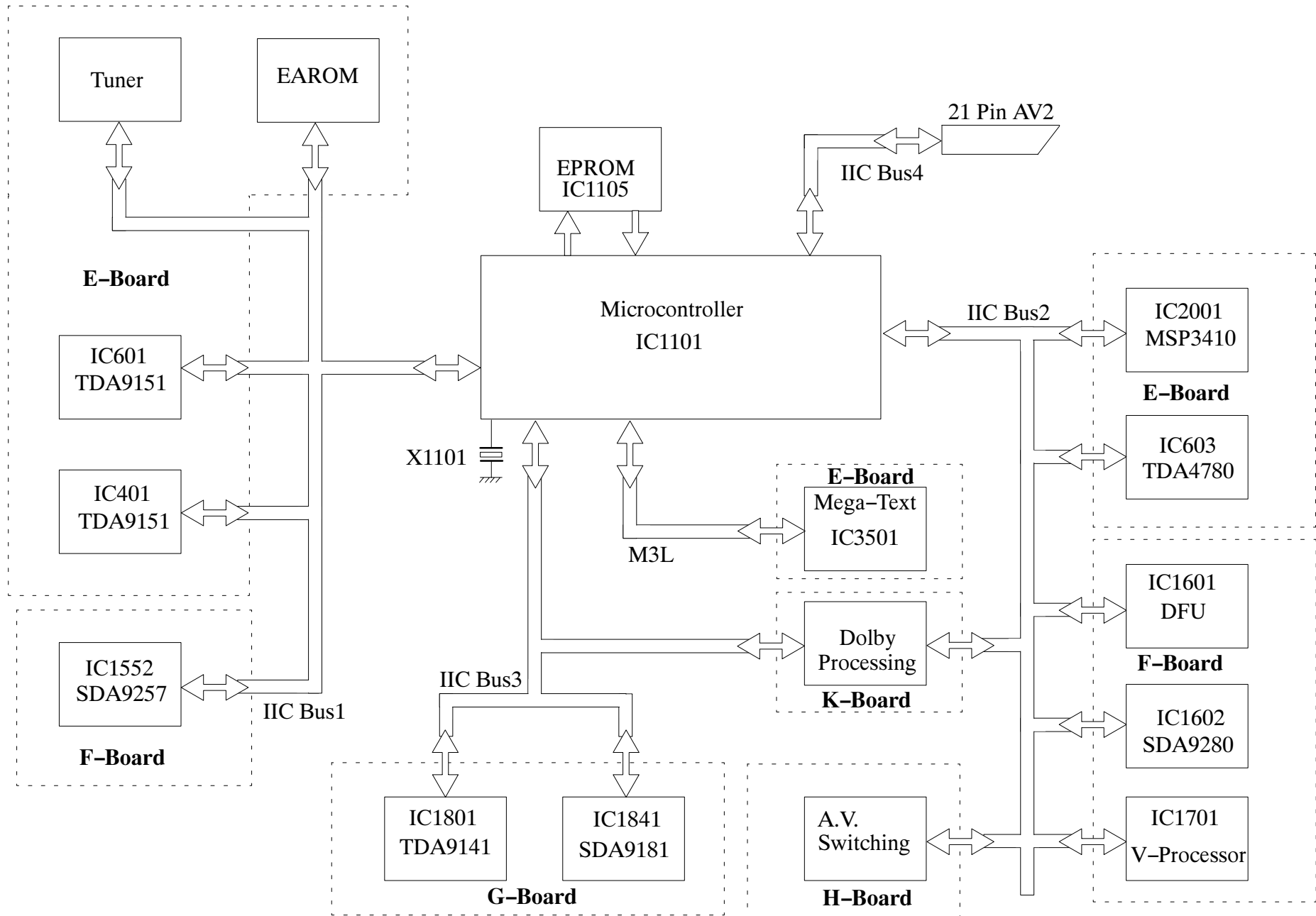

DOLBY PRO LOGIC PROCESSING

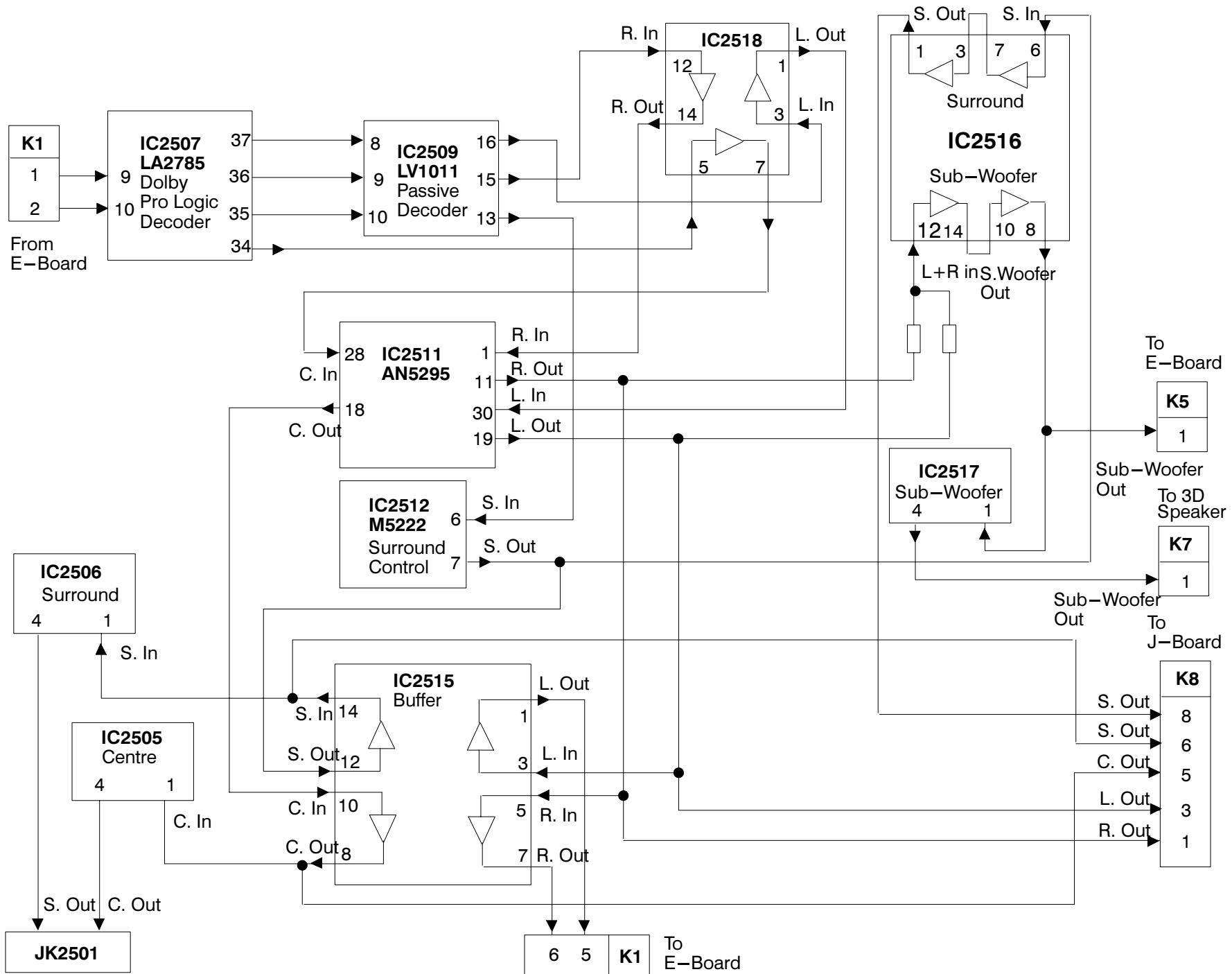

SCHEMATIC DIAGRAM FOR MODELS TX–W32D2DP (EURO–3HW CHASSIS)

IMPORTANT SAFETY NOTICE

Components identified by  mark have special characteristics important for safety. When replacing any of these components, use only manufacturer's specified parts.

Notes

1. RESISTOR
All resistors are carbon 1/4W resistor, unless marked.
Unit of resistance is OHM (Ω) (K=1,000, M=1,000,000).
2. CAPACITOR
All capacitors are ceramic 50V capacitors, unless marked, the unit of capacitance is μ F unless otherwise stated.
3. COIL
Unit of inductance is μ H, unless otherwise stated.
4. TEST POINT



Test Point Position

5. EARTH SYMBOL



Chassis Earth (cold)



Line Earth (Hot)

6. VOLTAGE MEASUREMENT

Voltage is measured by a DC voltmeter.

Measurement conditions are as follows:

Power source	AC 220–240V, 50Hz
Receiving Signal	Colour Bar signal (RF)
All customer controls	Maximum position

- 7.



Indicates the Video signal path



Indicates the Audio signal path



Indicates the Vertical/Horizontal signal path

8. This schematic diagram is the latest at the time of printing and is subject to change without notice.

Precautions

- a. Do not touch the hot part, or the hot and cold parts at the same time, as you are liable to a shock hazard.
- b. Do not short-circuit the hot and cold circuits as electrical components may be damaged.
- c. Do not connect an instrument, such as an oscilloscope, to the hot and cold circuits simultaneously, as this may cause fuse failure. Connect the earth of the instruments to the earth connection of the circuit being measured.
- d. Make sure to disconnect the power plug before removing the chassis.

Remarks

1. The Power Circuit contains a circuit area which uses a separate power supply to isolate the earth connection. The circuit is defined by HOT and COLD indications in the schematic diagram. All circuits, except the Power Circuit, are COLD.

PARTS LOCATION

NOTE :

The numbers on the exploded view below refer to the miscellaneous section of the Replacement Parts List.

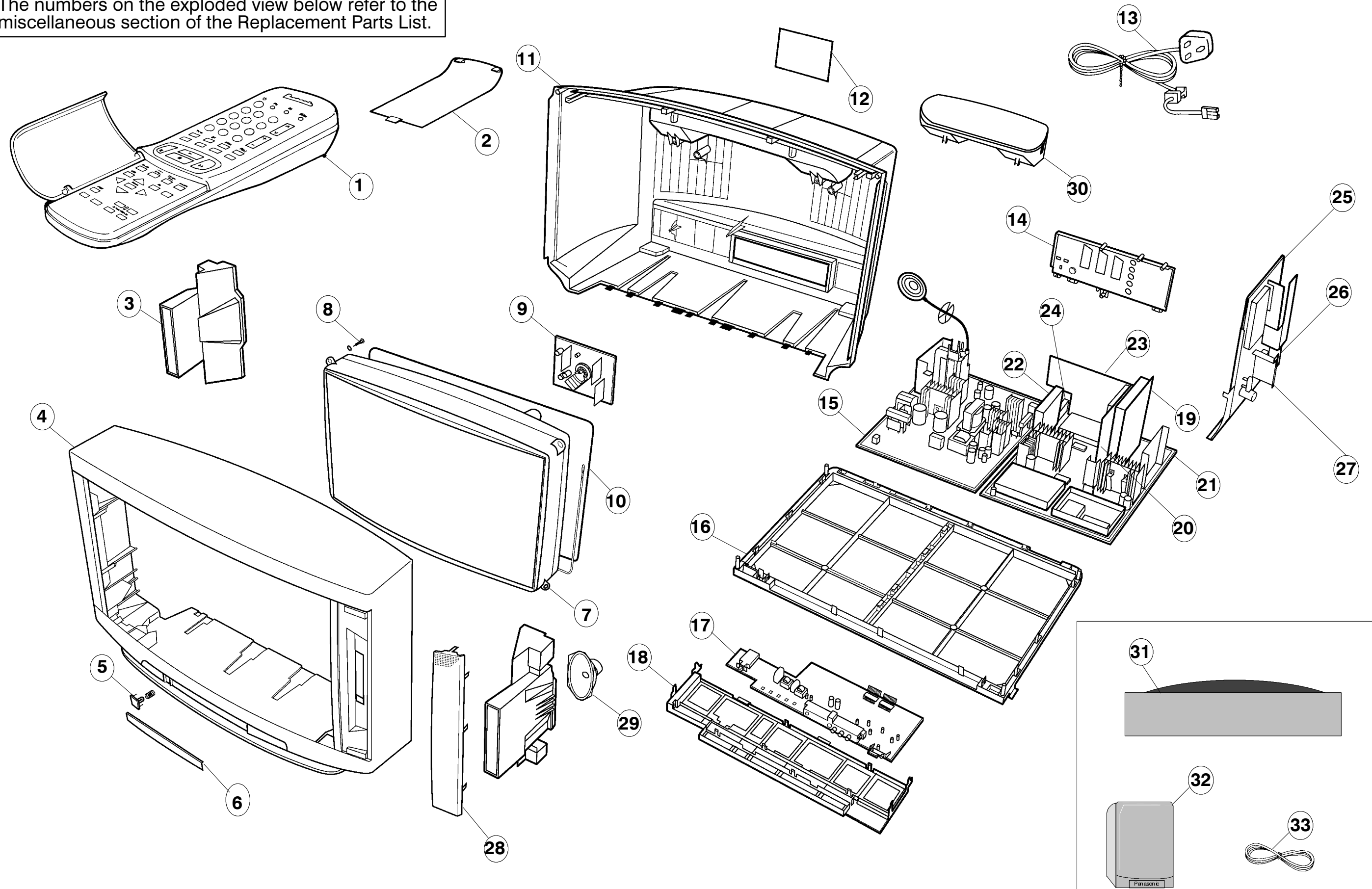

REPLACEMENT PARTS LIST

Important Safety notice

Components identified by Δ mark have special characteristics important for safety.
When replacing any of these components, use only manufacturer's specified parts.

Ref No.	Part No.	Description
MISCELLANEOUS COMPONENTS		
1)	EUR51924	REMOTE CONTROL
2)	UR51EC780	BATTERY COVER (REMOTE)
3)	TKK8E026	SPEAKER REFLECTOR
4)	TKY8E110	CABINET Δ
5)	TBX8E033	POWER BUTTON
6)	TKP8E1149	LID
7)	W76LFC185X05	CRT
8)	THT1062	CRT FIXING SCREW
9)	TNPA0292AA	Y-PC.B. Δ
10)	TLK8E05123	DEGUASS COIL Δ
11)	TKU8E00290	BACK COVER Δ
12)	TBM8E1608	MODEL LABEL
13)	TSX8E0018	POWER CORD Δ
14)	TKP8E1162	AV PANEL
15)	TNPH0063AD	E P.C.B. Δ
16)	TMX8E014-1	CHASSIS FRAME Δ
17)	TNPA0291AA	M PCB Δ
18)	TMW8E023	CONTROL BRACKET Δ
19)	TNPA0294AA	F P.C.B. Δ
20)	TNPA0297AA	G P.C.B. Δ
21)	TNPA0295AE	D P.C.B. Δ
22)	TNPA0298AA	B P.C.B. Δ
23)	TNPA0293AC	H P.C.B. Δ
24)	ENV87D02G3	TUNER Δ
25)	TNPA0370AB	K P.C.B. Δ
26)	TNPA0458AA	J P.C.B. Δ
27)	TNP8EC002AB	C P.C.B. Δ
28)	TKP8E1148	NET
29)	EAGG1218F2	SPEAKER
30)	EAB10102B2	3D SPEAKER
31)	EAS8E050-B	DOLBY CENTRE SPEAKER
32)	EAS8E002-A	DOLBY REAR SPEAKER
33)	TSX8E0015S	DOLBY SPEAKER WIRE 12M
	TS-400DP	TV STAND AND SPEAKER PACK
	PCS-068A-1	68 PIN I.C. SOCKET
	TBM173052	BADGE
	TBM8E1532-2	PRESET PANEL
	TEK6940	LID CATCHER
	TKP8E1160	FRONT PANEL RIGHT
	TKP8E1167	FRONT PANEL LEFT
	TMW8E017	L.E.D. HOLDER
	TMX8E015	PCB SUPPORT BRACKET
	TPC8E4594	OUTER CARTON
	TPD8E562	CUSHION
	TQB8E2240-2	INST BOOK Δ
	TLK8E05124	GEOMAGNETIC CORRECTION COIL
	832AG11D-ESL	I.C. SOCKET
MOD7	TES4537	SPRING
MOD12	31221212478	FIX CLIP
MOE12	TES4537	SPRING
CAPACITOR		
C002	ECUV1H102JCX	S.M. CAP 50V 1nF
C003	ECA1HM101GB	ELECT 50V 100 μ F
C004	ECUV1H102JCX	S.M. CAP 50V 1nF
C005	ECUV1H102JCX	S.M. CAP 50V 1nF
C006	ECUV1H102JCX	S.M. CAP 50V 1nF
C007	ECUV1H102JCX	S.M. CAP 50V 1nF
C009	ECA1HMR22GB	ELECT 50V 0.22 μ F
C010	ECUV1H102KBX	S.M. CAP 50V 1nF

Ref No.	Part No.	Description
C014	ECUV1H103ZFX	S.M. CAP 50V 10nF
C015	ECUV1H390JCX	S.M. CAP 50V 39pF
C016	ECUV1H390JCX	S.M. CAP 50V 39pF
C017	ECA1CM470GB	ELECT 16V 47 μ F
C019	ECUV1H561JCX	S.M. CAP 50V 560pF
C020	ECUV1H103ZFX	S.M. CAP 50V 10nF
C022	ECUV1H103ZFX	S.M. CAP 50V 10nF
C023	ECUV1H681JCX	S.M. CAP 50V 680pF
C024	ECUV1H103ZFX	S.M. CAP 50V 10nF
C025	ECUV1H101JCX	S.M. CAP 50V 100pF
C026	ECUV1H681JCX	S.M. CAP 50V 680pF
C101	ECUV1H151JCX	S.M. CAP 50V 150pF
C103	ECUV1H100DCX	S.M. CAP 50V 10pF
C107	ECUV1H104ZFX	S.M. CAP 50V 100nF
C108	ECUV1H102KBX	S.M. CAP 50V 1nF
C110	ECUV1H102KBX	S.M. CAP 50V 1nF
C112	ECUV1H104ZFX	S.M. CAP 50V 100nF
C113	ECUV1H102KBX	S.M. CAP 50V 1nF
C114	ECUV1H102KBX	S.M. CAP 50V 1nF
C116	ECUV1H104ZFX	S.M. CAP 50V 100nF
C117	ECUV1H104ZFX	S.M. CAP 50V 100nF
C118	ECUV1H331JCX	S.M. CAP 50V 330pF
C119	ECEA1HKA2R2	ELECT 50V 2.2 μ F
C120	ECEA1HKAR47	ELECT 50V 0.47 μ F
C122	ECUV1H104ZFX	S.M. CAP 50V 100nF
C123	ECUV1H104ZFX	S.M. CAP 50V 100nF
C124	ECUV1H104ZFX	S.M. CAP 50V 100nF
C126	ECUV1H104ZFX	S.M. CAP 50V 100nF
C127	ECEA1HKAR47	ELECT 50V 0.47 μ F
C128	ECUV1H104ZFX	S.M. CAP 50V 100nF
C129	ECUV1H104ZFX	S.M. CAP 50V 100nF
C130	ECUV1H121JCX	S.M. CAP 50V 120pF
C131	ECUV1H104ZFX	S.M. CAP 50V 100nF
C132	ECUV1H270JPX	S.M. CAP 50V 27pF
C133	ECUV1H104ZFX	S.M. CAP 50V 100nF
C135	ECEA1CKA100	ELECT 16V 10 μ F
C137	ECEA1HKA010	ELECT 50V 1 μ F
C138	ECUV1H102KBX	S.M. CAP 50V 1nF
C139	ECUV1H390JPX	S.M. CAP 50V 39pF
C140	ECUV1H150JCX	S.M. CAP 50V 15pF
C141	ECUV1H683ZFX	S.M. CAP 50V 68nF
C143	ECEA1CKA100	ELECT 16V 10 μ F
C144	ECUV1H104ZFX	S.M. CAP 50V 100nF
C251	ECQM1H474J	FILM 50V 470nF
C252	ECUV1H222JCX	S.M. CAP 50V 2.2nF
C253	ECUV1H473KBX	S.M. CAP 50V 47nF
C254	ECUV1H103KBX	S.M. CAP 50V 10nF
C255	ECEA1CN100	ELECT 16V 10 μ F
C256	ECA1HM330B	ELECT 50V 33 μ F
C257	ECA1HM100GB	ELECT 50V 10 μ F
C258	ECQM1H474J	FILM 50V 470nF
C259	ECUV1H222JCX	S.M. CAP 50V 2.2nF
C260	ECUV1H473KBX	S.M. CAP 50V 47nF
C261	ECUV1H103KBX	S.M. CAP 50V 10nF
C262	ECEA1CN100	ELECT 16V 10 μ F
C263	ECA1HM330B	ELECT 50V 33 μ F
C264	ECA1HM100GB	ELECT 50V 10 μ F
C265	ECUV1H223KBX	S.M. CAP 50V 22nF
C266	ECUV1H223KBX	S.M. CAP 50V 22nF
C267	ECUV1H103ZFX	S.M. CAP 50V 10nF
C268	ECUV1H223ZFX	S.M. CAP 50V 22nF
C269	ECA1EM222GB	ELECT 25V 2200 μ F
C270	ECA1EM222GB	ELECT 25V 2200 μ F
C271	ECA1HM010GB	ELECT 50V 1 μ F
C272	ECA1HM010GB	ELECT 50V 1 μ F
C273	ECA1HM010GB	ELECT 50V 1 μ F
C274	ECA1HM010GB	ELECT 50V 1 μ F
C275	ECUV1C104KBX	S.M. CAP 16V 100nF
C276	ECUV1C104KBX	S.M. CAP 16V 100nF
C277	ECEA1HU471	ELECT 50V 470 μ F
C281	ECUV1H104ZFX	S.M. CAP 50V 100nF
C282	ECUV1H561JCX	S.M. CAP 50V 560pF

Ref No.	Part No.	Description	
C283	ECUV1H561JCX	S.M. CAP 50V 560pF	
C352	ECUV1H224ZFX	S.M. CAP 50V 220nF	
C353	ECUV1H103KBX	S.M. CAP 50V 10nF	
C354	ECKC2H103J	CERAMIC 500V 10nF	△
C355	ECKC2H102J	CERAMIC 500V 1nF	△
C362	ECUV1H224ZFX	S.M. CAP 50V 220nF	
C363	ECUV1H103KBX	S.M. CAP 50V 10nF	
C364	ECKC2H103J	CERAMIC 500V 10nF	△
C365	ECKC2H102J	CERAMIC 500V 1nF	△
C372	ECUV1H224ZFX	S.M. CAP 50V 220nF	
C373	ECUV1H103KBX	S.M. CAP 50V 10nF	
C374	ECKC2H103J	CERAMIC 500V 10nF	△
C375	ECKC2H102J	CERAMIC 500V 1nF	△
C381	ECA1HM101GB	ELECT 50V 100µF	
C382	ECA0JM471GB	ELECT 6.3V 470µF	
C383	ECUV1H103KBX	S.M. CAP 50V 10nF	
C384	ECQM2104KZ	FILM 250V 100nF	
C385	ECEA2EU220	ELECT 250V 22µF	
C386	ECKC3D152J	CERAMIC 2KV 1.5nF	△
C395	ECQM1H104J	FILM 50V 100nF	
C402	ECUV1H104ZFX	S.M. CAP 50V 100nF	
C403	ECA1AM332E	ELECT 10V 3300µF	
C404	ECUV1H104ZFX	S.M. CAP 50V 100nF	
C405	ECUV1H104ZFX	S.M. CAP 50V 100nF	
C406	ECUV1H471JCX	S.M. CAP 50V 470pF	
C409	ECUV1H101JCX	S.M. CAP 50V 100pF	
C413	ECUV1H561KBX	S.M. CAP 50V 560pF	
C451	ECUV1H104ZFX	S.M. CAP 50V 100nF	
C452	ECA1EM332E	ELECT 25V 3300µF	
C453	ECEA1HU101	ELECT 50V 100µF	
C455	ECEA1HN100	ELECT 50V 10µF	
C456	ECQV1104JZ3	FILM 100V 100pF	
C457	ECUV1H102JCX	S.M. CAP 50V 1nF	
C461	ECUV1C224KBX	S.M. CAP 16V 220nF	
C462	ECKC3A471J	CERAMIC 1KV 470pF	△
C463	ECUV1H102KBX	S.M. CAP 50V 1nF	
C464	ECKC1H102J	CERAMIC 50V 1000pF	
C501	ECQM1H224J	FILM 50V 220nF	
C502	ECQM2683JZ	FILM 250V 68nF	
C503	ECKC2H102J	CERAMIC 500V 1nF	△
C504	ECQB1H223K	FILM 50V 22nF	
C506	ECKC2H102J	CERAMIC 500V 1nF	△
C552	TAC4S6T102JC	CERAMIC 1500V 1nF	
C553	ECQP1223JZW	FILM 100V 22nF	
C555	TAC4R6T622JC	CERAMIC 1500V 6200pF	
C556	ECEA2CNR47SB	ELECT 160V R47µF	
C557	ECKC2H331J	CERAMIC 500V 330pF	△
C558	ECA2EM330B	ELECT 250V 33µF	
C559	ECKC2H101J	CERAMIC 500V 100pF	△
C560	ECA1EM332E	ELECT 25V 3300µF	
C561	ECKC2H561J	CERAMIC 500V 560pF	△
C562	ECA1JM220B	ELECT 63V 22µF	
C563	TAC7A2D564JC	CERAMIC 1500V 560pF	
C564	ECKC1H472J	CERAMIC 50V 4.7nF	
C565	ECQP1223JZW	FILM 100V 22nF	
C571	ECQV1H105JZ	FILM 50V 1µF	
C572	TAC4R6T682JC	CERAMIC 1500V 6800pF	
C573	ECQF4153JZH	FILM 400V 15nF	
C574	TAC1114Z564A	CERAMIC 400V 560nF	
C575	TAC1114Z564A	CERAMIC 400V 560nF	
C577	TAC1114Z105A	CERAMIC 400V 1000nF	
C580	ECKC1H103JB	CERAMIC 50V 10nF	
C581	ECQF4153JZH	FILM 400V 15nF	
C584	ECKC3D391J	CERAMIC 2KV 390pF	△
C585	ECKC3A471J	CERAMIC 1KV 470pF	△
C586	ECKC1H103JB	CERAMIC 50V 10nF	
C601	ECUV1H104ZFX	S.M. CAP 50V 100nF	
C602	ECUV1H104ZFX	S.M. CAP 50V 100nF	
C603	ECUV1H104ZFX	S.M. CAP 50V 100nF	
C604	ECUV1H104ZFX	S.M. CAP 50V 100nF	
C605	ECUV1H104ZFX	S.M. CAP 50V 100nF	
C606	ECUV1H104ZFX	S.M. CAP 50V 100nF	
C608	ECUV1H104ZFX	S.M. CAP 50V 100nF	
C609	ECUV1H180JCX	S.M. CAP 50V 18pF	
C610	ECUV1H150JCX	S.M. CAP 50V 15pF	
C611	ECUV1H104ZFX	S.M. CAP 50V 100nF	
C612	ECUV1H332ZFX	S.M. CAP 50V 3.3nF	
C613	ECUV1C474ZFX	S.M. CAP 16V 470nF	
C614	ECUV1H332ZFX	S.M. CAP 50V 3.3nF	
C615	ECUV1H104ZFX	S.M. CAP 50V 100nF	
C616	ECUV1H104ZFX	S.M. CAP 50V 100nF	

Ref No.	Part No.	Description	
C617	ECA1CM220GB	ELECT 16V 22µF	
C618	ECUV1H104ZFX	S.M. CAP 50V 100nF	
C619	ECUV1H104ZFX	S.M. CAP 50V 100nF	
C620	ECUV1H104ZFX	S.M. CAP 50V 100nF	
C621	ECUV1H104ZFX	S.M. CAP 50V 100nF	
C622	ECUV1H104ZFX	S.M. CAP 50V 100nF	
C623	ECUV1H103ZFX	S.M. CAP 50V 10nF	
C624	ECUV1H103ZFX	S.M. CAP 50V 10nF	
C625	ECUV1H103ZFX	S.M. CAP 50V 10nF	
C626	ECUV1H103ZFX	S.M. CAP 50V 10nF	
C627	ECUV1H103ZFX	S.M. CAP 50V 10nF	
C628	ECUV1H103ZFX	S.M. CAP 50V 10nF	
C629	ECUV1H103ZFX	S.M. CAP 50V 10nF	
C630	ECUV1H103ZFX	S.M. CAP 50V 10nF	
C631	ECUV1H103ZFX	S.M. CAP 50V 10nF	
C632	ECUV1H103ZFX	S.M. CAP 50V 10nF	
C633	ECUV1H470JCX	S.M. CAP 50V 47pF	
C634	ECA1AM221GB	ELECT 10V 220µF	
C635	ECA1HM220GB	ELECT 50V 22µF	
C636	ECA1HM010GB	ELECT 50V 1µF	
C637	ECQM1H224J	FILM 50V 220nF	
C638	ECA1HM010GB	ELECT 50V 1µF	
C639	ECQM1H224J	FILM 50V 220nF	
C640	ECQM1H224J	FILM 50V 220nF	
C641	ECQM1H224J	FILM 50V 220nF	
C642	ECA1AM470GB	ELECT 10V 47µF	
C643	ECUV1H104ZFX	S.M. CAP 50V 100nF	
C644	ECA1CM470GB	ELECT 16V 47µF	
C645	ECUV1H104ZFX	S.M. CAP 50V 100nF	
C646	ECUV1H104ZFX	S.M. CAP 50V 100nF	
C647	ECEA1CN470	ELECT 16V 47µF	
C648	ECEA1CN470	ELECT 16V 47µF	
C651	ECUV1H820JCX	S.M. CAP 50V 82pF	
C654	ECUV1H393KBX	S.M. CAP 50V 39nF	
C655	ECUV1E563KBX	S.M. CAP 25V 56nF	
C657	ECUV1C474ZFX	S.M. CAP 16V 470nF	
C659	ECUV1H821KBX	S.M. CAP 50V 820pF	
C661	ECUV1H103ZFX	S.M. CAP 50V 10nF	
C662	ECUV1H470JCX	S.M. CAP 50V 47pF	
C663	ECUV1H150JCX	S.M. CAP 50V 15pF	
C703	ECUV1C224KBX	S.M. CAP 16V 220nF	
C752	ECKC2H103J	CERAMIC 500V 10nF	△
C803	ECQE2A474MWB	FILM 100V 470nF	
C804	222233510154	CAPACITOR 150nF	
C806	ECQE6104K	FILM 600V 100nF	△
C807	ECQB1H473K	FILM 50V 47nF	
C808	ECQB1H333J	FILM 50V 33nF	
C810	222233510154	CAPACITOR 150nF	
C811	ECQB1H104J	FILM 50V 100nF	
C812	ECQB1H222J	FILM 50V 2200pF	
C813	ECKC2H472J	CERAMIC 500V 4.7nF	△
C814	ECKC2H472J	CERAMIC 500V 4.7nF	△
C815	ECA1CM331B	ELECT 16V 330µF	
C816	ECQB1H122J	FILM 50V 1.2nF	
C817	ECKC2H472J	CERAMIC 500V 4.7nF	△
C818	ECKC2H472J	CERAMIC 500V 4.7nF	△
C819	ECOS2GA181DB	ELECT 400V 180pF	
C820	ECOS2GA181DB	ELECT 400V 180pF	
C821	ECQB1H222J	FILM 50V 2200pF	
C822	ECKC3D102J	CERAMIC 2KV 1nF	△
C823	EEUFA1V221B	CERAMIC 35V 220pF	
C824	ECQB1H121KF3	FILM 50V 120pF	
C826	ECQB1H473K	FILM 50V 47nF	
C827	ECKCNS332J	CERAMIC 1.2KV 3.3nF	△
C830	ECQE4105JFW	FILM 400V 1µF	
C831	ECKC3D471JB	CERAMIC 2KV 470pF	△
C833	ECQB1H682K	FILM 50V 6.8nF	
C834	ECQB1H471KF3	FILM 50V 470pF	
C835	ECQB1H152K	FILM 50V 1.5nF	
C849	ECKC2H471J	CERAMIC 500V 470pF	△
C851	ECQM1H104J	FILM 50V 100nF	
C852	ECKC3D102J	CERAMIC 2KV 1nF	△
C853	ECA1CM471GB	ELECT 16V 470µF	
C854	ECA1EM471GB	ELECT 16V 470µF	
C855	ECEA1HU102	ELECT 50V 1000µF	
C856	ECEA1HU471	ELECT 50V 470µF	
C857	ECA1EM471GB	ELECT 25V 470µF	
C858	ECOS2EA271BB	ELECT 250V 270pF	
C859	ECKC2H471J	CERAMIC 500V 470pF	△
C861	ECOS2EA221AB	ELECT 250V 220µF	
C863	ECA1EM222GB	ELECT 25V 2200µF	

Ref No.	Part No.	Description	
864	ECA0JM102GB	ELECT	6.3V 1000µF
C866	ECA1HM101GB	ELECT	50V 100µF
C867	ECA1CM222GB	ELECT	16V 2200µF
C868	ECA1CM100GB	ELECT	16V 10µF
C871	ECA0JM102GB	ELECT	6.3V 1000µF
C872	ECA1CM222GB	ELECT	16V 2200µF
C901	ECUV1H030CCX	S.M. CAP	50V 30pF
C902	ECA1VM101GB	ELECT	35V 100µF
C903	ECA1CM470GB	ELECT	16V 47µF
C904	ECUV1H103ZFX	S.M. CAP	50V 10nF
C905	ECA1CM100GB	ELECT	16V 10µF
C906	ECUV1H151JCX	S.M. CAP	50V 150pF
C908	ECUV1H151JCX	S.M. CAP	50V 150pF
C909	ECKC2H472J	CERAMIC	500V 4.7nF
C910	ECKC2H472J	CERAMIC	500V 4.7nF
C911	ECUV1H151JCX	S.M. CAP	50V 150pF
C912	ECEA2EU220	ELECT	250V 22µF
C913	ECA1HM101GB	ELECT	50V 100µF
C914	ECA1HM101GB	ELECT	50V 100µF
C915	ECA1CM471GB	ELECT	16V 470µF
C916	ECEA2EU220	ELECT	250V 22µF
C917	ECA1HM100GB	ELECT	50V 10µF
C918	ECUV1H103ZFX	S.M. CAP	50V 10nF
C919	ECCR2H270J	CERAMIC	500V 27pF
C1051	ECKC1H101J	CERAMIC	50V 100pF
C1052	ECA1VM470B	ELECT	35V 47µF
C1053	ECKC1H103JB	CERAMIC	50V 10nF
C1102	ECUV1H104ZFX	S.M. CAP	50V 100nF
C1103	ECUV1H104ZFX	S.M. CAP	50V 100nF
C1104	ECA0JM101G	ELECT	6.3V 100µF
C1105	ECUV1H330JCX	S.M. CAP	50V 33pF
C1106	ECUV1H330JCX	S.M. CAP	50V 33pF
C1107	ECUV1H391JCX	S.M. CAP	50V 390pF
C1108	ECUV1H103ZFX	S.M. CAP	50V 10nF
C1109	ECUV1H472KBX	S.M. CAP	50V 4.7nF
C1110	ECUV1H104ZFX	S.M. CAP	50V 100nF
C1111	ECUV1H101JCX	S.M. CAP	50V 100pF
C1112	ECUV1H103ZFX	S.M. CAP	50V 10nF
C1113	ECUV1H102JCX	S.M. CAP	50V 1nF
C1114	ECUV1H102JCX	S.M. CAP	50V 1nF
C1115	ECUV1H102JCX	S.M. CAP	50V 1nF
C1126	ECUV1H104ZFX	S.M. CAP	50V 100nF
C1127	ECUV1H104ZFX	S.M. CAP	50V 100nF
C1129	ECA1AM470GB	ELECT	10V 47µF
C1130	ECUV1H104ZFX	S.M. CAP	50V 100nF
C1131	ECUV1H101JCX	S.M. CAP	50V 100pF
C1133	ECUV1C184KBX	S.M. CAP	16V 180nF
C1134	ECUV1H103KBX	S.M. CAP	50V 10nF
C1135	ECUV1H103ZFX	S.M. CAP	50V 10nF
C1136	ECUV1H101JCX	S.M. CAP	50V 100pF
C1137	ECUV1H102KBX	S.M. CAP	50V 1nF
C1138	ECUV1H104ZFX	S.M. CAP	50V 100nF
C1302	ECUV1H150JCX	S.M. CAP	50V 15pF
C1304	ECUV1H103ZFX	S.M. CAP	50V 10nF
C1305	ECA1HM101GB	ELECT	50V 100µF
C1306	ECUV1H104ZFX	S.M. CAP	50V 100nF
C1307	ECUV1H104ZFX	S.M. CAP	50V 100nF
C1308	ECA1HM101GB	ELECT	50V 100µF
C1309	ECUV1H104ZFX	S.M. CAP	50V 100nF
C1310	ECUV1H104ZFX	S.M. CAP	50V 100nF
C1311	ECUV1H104ZFX	S.M. CAP	50V 100nF
C1312	ECUV1H104ZFX	S.M. CAP	50V 100nF
C1313	ECUV1H104ZFX	S.M. CAP	50V 100nF
C1314	ECUV1H104ZFX	S.M. CAP	50V 100nF
C1315	ECUV1H104ZFX	S.M. CAP	50V 100nF
C1316	ECA1HM101GB	ELECT	50V 100µF
C1317	ECUV1H104ZFX	S.M. CAP	50V 100nF
C1318	ECA1HM101GB	ELECT	50V 100µF
C1321	ECUV1H104ZFX	S.M. CAP	50V 100nF
C1322	ECUV1H101JCX	S.M. CAP	50V 100pF
C1323	ECA1HM101GB	ELECT	50V 100µF
C1324	ECA1HM101GB	ELECT	50V 100µF
C1325	ECUV1H103ZFX	S.M. CAP	50V 10nF
C1326	ECUV1H104ZFX	S.M. CAP	50V 100nF
C1327	ECUV1H104ZFX	S.M. CAP	50V 100nF
C1508	ECUV1H103KBX	S.M. CAP	50V 10nF
C1509	ECA1CM100GB	ELECT	16V 10µF
C1518	ECA1HM101GB	ELECT	50V 100µF
C1519	ECA1CM470GB	ELECT	16V 47µF
C1520	ECA1CM470GB	ELECT	16V 47µF
C1521	ECUV1H390JCX	S.M. CAP	50V 39pF
C1524	ECUV1H221JCX	S.M. CAP	50V 220pF

△
△

Ref No.	Part No.	Description	
C1525	ECUV1H391JCX	S.M. CAP	50V 390pF
C1528	ECUV1H390JCX	S.M. CAP	50V 39pF
C1529	ECUV1H221JCX	S.M. CAP	50V 220pF
C1531	ECUV1H391JCX	S.M. CAP	50V 390pF
C1532	ECUV1H151JCX	S.M. CAP	50V 150pF
C1533	ECUV1H750JCX	S.M. CAP	50V 75pF
C1534	ECUV1H391JCX	S.M. CAP	50V 390pF
C1537	ECA0JM102GB	ELECT	6.3V 1000µF
C1552	ECUV1H104ZFX	S.M. CAP	50V 100nF
C1554	ECUV1H104ZFX	S.M. CAP	50V 100nF
C1555	ECA0JM331GB	ELECT	6.3V 330pF
C1556	ECUV1H270JCX	S.M. CAP	50V 27pF
C1557	ECUV1H270JCX	S.M. CAP	50V 27pF
C1559	ECUV1H103KBX	S.M. CAP	50V 10nF
C1560	ECUV1H103KBX	S.M. CAP	50V 10nF
C1561	ECUV1H104ZFX	S.M. CAP	50V 100nF
C1562	ECA0JM331GB	ELECT	6.3V 330pF
C1564	ECUV1H104ZFX	S.M. CAP	50V 100nF
C1575	ECUV1H104ZFX	S.M. CAP	50V 100nF
C1576	ECUV1H104ZFX	S.M. CAP	50V 100nF
C1577	ECA1CM470GB	ELECT	16V 47µF
C1579	ECUV1H104ZFX	S.M. CAP	50V 100nF
C1580	ECUV1H104ZFX	S.M. CAP	50V 100nF
C1583	ECUV1H104ZFX	S.M. CAP	50V 100nF
C1584	ECUV1H104ZFX	S.M. CAP	50V 100nF
C1585	ECUV1H104ZFX	S.M. CAP	50V 100nF
C1586	ECUV1H104ZFX	S.M. CAP	50V 100nF
C1588	ECA1CM470GB	ELECT	16V 47µF
C1590	ECUV1H104ZFX	S.M. CAP	50V 100nF
C1591	ECUV1H104ZFX	S.M. CAP	50V 100nF
C1592	ECUV1H104ZFX	S.M. CAP	50V 100nF
C1593	ECA1CM470GB	ELECT	16V 47µF
C1594	ECUV1H104ZFX	S.M. CAP	50V 100nF
C1595	ECUV1H104ZFX	S.M. CAP	50V 100nF
C1596	ECUV1H104ZFX	S.M. CAP	50V 100nF
C1599	ECA1CM470GB	ELECT	16V 47µF
C1601	ECUV1H104ZFX	S.M. CAP	50V 100nF
C1602	ECUV1H104ZFX	S.M. CAP	50V 100nF
C1603	ECUV1H103KBX	S.M. CAP	50V 10nF
C1604	ECUV1H104ZFX	S.M. CAP	50V 100nF
C1605	ECUV1H104ZFX	S.M. CAP	50V 100nF
C1606	ECUV1H104ZFX	S.M. CAP	50V 100nF
C1607	ECUV1H104ZFX	S.M. CAP	50V 100nF
C1608	ECA1CM470GB	ELECT	16V 47µF
C1610	ECUV1H104ZFX	S.M. CAP	50V 100nF
C1611	ECUV1H103KBX	S.M. CAP	50V 10nF
C1612	ECUV1H104ZFX	S.M. CAP	50V 100nF
C1613	ECUV1H104ZFX	S.M. CAP	50V 100nF
C1614	ECUV1H104ZFX	S.M. CAP	50V 100nF
C1615	ECUV1H101JCX	S.M. CAP	50V 100pF
C1616	ECUV1H152JCX	S.M. CAP	50V 1.5pF
C1617	ECUV1H104ZFX	S.M. CAP	50V 100nF
C1618	ECUV1H104ZFX	S.M. CAP	50V 100nF
C1619	ECUV1H104ZFX	S.M. CAP	50V 100nF
C1620	ECUV1H104ZFX	S.M. CAP	50V 100nF
C1621	ECA1CM470GB	ELECT	16V 47µF
C1622	ECUV1H104ZFX	S.M. CAP	50V 100nF
C1625	ECA1CM470GB	ELECT	16V 47µF
C1641	ECA1CM470GB	ELECT	16V 47µF
C1642	ECUV1H104ZFX	S.M. CAP	50V 100nF
C1701	ECA1CM470GB	ELECT	16V 47µF
C1702	ECUV1H104ZFX	S.M. CAP	50V 100nF
C1703	ECUV1H104ZFX	S.M. CAP	50V 100nF
C1704	ECUV1H104ZFX	S.M. CAP	50V 100nF
C1705	ECUV1H104ZFX	S.M. CAP	50V 100nF
C1706	ECUV1H104ZFX	S.M. CAP	50V 100nF
C1707	ECUV1H104ZFX	S.M. CAP	50V 100nF
C1708	ECUV1H104ZFX	S.M. CAP	50V 100nF
C1709	ECUV1H104ZFX	S.M. CAP	50V 100nF
C1710	ECUV1H104ZFX	S.M. CAP	50V 100nF
C1711	ECUV1H103KBX	S.M. CAP	50V 10nF
C1712	ECUV1H104ZFX	S.M. CAP	50V 100nF
C1713	ECUV1H104ZFX	S.M. CAP	50V 100nF
C1714	ECUV1H104ZFX	S.M. CAP	50V 100nF
C1721	ECA1CM470GB	ELECT	16V 47µF
C1722	ECA1CM470GB	ELECT	16V 47µF
C1723	ECUV1H104ZFX	S.M. CAP	50V 100nF
C1724	ECUV1H104ZFX	S.M. CAP	50V 100nF
C1725	ECUV1H104ZFX	S.M. CAP	50V 100nF
C1726	ECUV1H104ZFX	S.M. CAP	50V 100nF
C1727	ECUV1H104ZFX	S.M. CAP	50V 100nF
C1728	ECUV1H104ZFX	S.M. CAP	50V 100nF

Ref No.	Part No.	Description
C1729	ECUV1H104ZFX S.M. CAP	50V 100nF
C1730	ECUV1H104ZFX S.M. CAP	50V 100nF
C1731	ECUV1H104ZFX S.M. CAP	50V 100nF
C1732	ECUV1H104ZFX S.M. CAP	50V 100nF
C1733	ECUV1H104ZFX S.M. CAP	50V 100nF
C1734	ECUV1H104ZFX S.M. CAP	50V 100nF
C1735	ECUV1H104ZFX S.M. CAP	50V 100nF
C1736	ECUV1H104ZFX S.M. CAP	50V 100nF
C1740	ECUV1H102KBX S.M. CAP	50V 1nF
C1801	ECUV1C104KBX S.M. CAP	16V 100nF
C1802	ECUV1C104KBX S.M. CAP	16V 100nF
C1803	ECUV1C104KBX S.M. CAP	16V 100nF
C1804	ECUV1C104KBX S.M. CAP	16V 100nF
C1805	ECUV1H104ZFX S.M. CAP	50V 100nF
C1806	ECUV1C104KBX S.M. CAP	16V 100nF
C1807	ECUV1C104KBX S.M. CAP	16V 100nF
C1808	ECUV1C104KBX S.M. CAP	16V 100nF
C1809	ECUV1C104KBX S.M. CAP	16V 100nF
C1810	ECUV1H103ZFX S.M. CAP	50V 10nF
C1811	ECUV1C104KBX S.M. CAP	16V 100nF
C1812	ECUV1H104ZFX S.M. CAP	50V 100nF
C1813	ECUV1H332KBX S.M. CAP	50V 3.3nF
C1814	ECUV1C104KBX S.M. CAP	16V 100nF
C1815	ECUV1H180JCX S.M. CAP	50V 18pF
C1816	ECUV1H150JCX S.M. CAP	50V 15pF
C1817	ECUV1H104ZFX S.M. CAP	50V 100nF
C1818	ECUV1H331JCX S.M. CAP	50V 330pF
C1819	ECUV1H331JCX S.M. CAP	50V 330pF
C1820	ECUV1H680JCX S.M. CAP	50V 68pF
C1821	ECUV1H103KBX S.M. CAP	50V 10nF
C1822	ECUV1H103KBX S.M. CAP	50V 10nF
C1823	ECUV1H104ZFX S.M. CAP	50V 100nF
C1824	ECA1AM470GB ELECT	10V 47µF
C1825	ECQB1H563K FILM	50V 56nF
C1826	ECUV1H152KBX S.M. CAP	50V 1.5pF
C1827	ECUV1H104ZFX S.M. CAP	50V 100nF
C1828	ECA1HM010GB ELECT	50V 1µF
C1829	ECUV1C104KBX S.M. CAP	16V 100nF
C1840	ECUV1C104KBX S.M. CAP	16V 100nF
C1843	ECUV1H104ZFX S.M. CAP	50V 100nF
C1845	ECA1AM470GB ELECT	10V 47µF
C1846	ECUV1H104ZFX S.M. CAP	50V 100nF
C1861	ECUV1H561KBX S.M. CAP	50V 560pF
C1862	ECUV1H561KBX S.M. CAP	50V 560pF
C1865	ECA1CM470GB ELECT	16V 47µF
C1881	ECUV1H104ZFX S.M. CAP	50V 100nF
C1882	ECA1AM470GB ELECT	10V 47µF
C1887	ECA1HM101GB ELECT	50V 100µF
C1888	ECUV1H104ZFX S.M. CAP	50V 100nF
C1891	ECUV1H332KBX S.M. CAP	50V 3.3nF
C1892	ECUV1C104KBX S.M. CAP	16V 100nF
C1894	ECA1AM470GB ELECT	10V 47µF
C1895	ECA1AM470GB ELECT	10V 47µF
C1896	ECUV1H104ZFX S.M. CAP	50V 100nF
C1897	ECA1AM330GB ELECT	10V 33µF
C1901	ECQM1H474J FILM	50V 470nF
C1902	ECQM1H474J FILM	50V 470nF
C1903	ECA1EM470GB ELECT	25V 47pF
C1904	ECKC1H103JB CERAMIC	50V 10nF
C2001	ECA1CM100GB ELECT	16V 10µF
C2002	ECUV1H104ZFX S.M. CAP	50V 100nF
C2003	ECUV1H104ZFX S.M. CAP	50V 100nF
C2004	ECUV1H102JCX S.M. CAP	50V 1nF
C2005	ECUV1H391JCX S.M. CAP	50V 390pF
C2006	ECUV1H391JCX S.M. CAP	50V 390pF
C2007	ECUV1H102JCX S.M. CAP	50V 1nF
C2008	ECUV1H102JCX S.M. CAP	50V 1nF
C2009	ECUV1H102JCX S.M. CAP	50V 1nF
C2010	ECUV1H102JCX S.M. CAP	50V 1nF
C2011	ECUV1H102JCX S.M. CAP	50V 1nF
C2012	ECUV1H102JCX S.M. CAP	50V 1nF
C2014	ECQM1H334J FILM	50V 330nF
C2017	ECA1CM100GB ELECT	16V 10µF
C2018	ECA1CM100GB ELECT	16V 10µF
C2019	ECA1HM101GB ELECT	50V 100µF
C2020	ECUV1H104ZFX S.M. CAP	50V 100nF
C2021	ECUV1H104ZFX S.M. CAP	50V 100nF
C2022	ECA1HM3R3GB ELECT	50V 3.3µF
C2023	ECUV1H471JCX S.M. CAP	50V 470pF
C2024	ECUV1H471JCX S.M. CAP	50V 470pF
C2025	ECUV1H221JCX S.M. CAP	50V 220pF
C2026	ECUV1H221JCX S.M. CAP	50V 220pF

Ref No.	Part No.	Description
C2027	ECUV1H221JCX S.M. CAP	50V 220pF
C2028	ECUV1H221JCX S.M. CAP	50V 220pF
C2029	ECUV1H221JCX S.M. CAP	50V 220pF
C2030	ECUV1H221JCX S.M. CAP	50V 220pF
C2031	ECUV1H104ZFX S.M. CAP	50V 100nF
C2032	ECA1CM100GB ELECT	16V 10µF
C2034	ECUV1H070DCX S.M. CAP	50V 7pF
C2035	ECUV1H560JCX S.M. CAP	50V 56pF
C2036	ECUV1H100DCX S.M. CAP	50V 10pF
C2037	ECUV1H220JCX S.M. CAP	50V 22pF
C2039	ECUV1H070DCX S.M. CAP	50V 7pF
C2040	ECUV1H560JCX S.M. CAP	50V 56pF
C2042	ECUV1H104ZFX S.M. CAP	50V 100nF
C2043	ECA1CM100GB ELECT	16V 10µF
C2044	ECUV1H010CCX S.M. CAP	50V 1pF
C2045	ECUV1H010CCX S.M. CAP	50V 1pF
C2050	ECUV1H223ZFX S.M. CAP	50V 22nF
C2051	ECUV1H223ZFX S.M. CAP	50V 22nF
C2052	ECUV1H103ZFX S.M. CAP	50V 10nF
C2053	ECUV1H103ZFX S.M. CAP	50V 10nF
C2054	ECA1CM331B ELECT	16V 330µF
C2055	ECA1CM102E ELECT	16V 1000µF
C2058	ECUV1H683ZFX S.M. CAP	50V 68nF
C2059	ECUV1H102KBX S.M. CAP	50V 1nF
C2060	ECUV1H102KBX S.M. CAP	50V 1nF
C2351	ECA1CM471GB ELECT	16V 470µF
C2352	ECA1CM471GB ELECT	16V 470µF
C2353	ECA1HM4R7GB ELECT	50V 4.7µF
C2354	ECKC1H103JB CERAMIC	50V 10nF
C2355	ECA1HMR33GB ELECT	50V 0.33µF
C2356	ECKC1H103JB CERAMIC	50V 10nF
C2360	ECKC1H103JB CERAMIC	50V 10nF
C2361	ECA1CM471GB ELECT	16V 470µF
C2362	ECA1CM471GB ELECT	16V 470µF
C2363	ECA1HM4R7GB ELECT	50V 4.7µF
C2364	ECKC1H103JB CERAMIC	50V 10nF
C2365	ECA1HMR33GB ELECT	50V 0.33µF
C2366	ECKC1H103JB CERAMIC	50V 10nF
C2401	ECA1HM101GB ELECT	50V 100µF
C2402	ECUV1H393KBX S.M. CAP	50V 39nF
C2405	ECA1HM4R7GB ELECT	50V 4.7µF
C2406	ECA1HM4R7GB ELECT	50V 4.7µF
C2407	ECA1HM4R7GB ELECT	50V 4.7µF
C2408	ECA1HM4R7GB ELECT	50V 4.7µF
C2409	ECA1HM4R7GB ELECT	50V 4.7µF
C2415	ECUV1H103ZFX S.M. CAP	50V 10nF
C2416	ECUV1H562KBX S.M. CAP	50V 5.6nF
C2418	ECQM1H104J FILM	50V 100nF
C2420	ECUV1H104KBX S.M. CAP	50V 100nF
C2421	ECA1VM101GB ELECT	35V 100µF
C2422	ECA1VM221B ELECT	35V 220µF
C2423	ECUV1H104KBX S.M. CAP	50V 100nF
C2424	ECA1CM220GB ELECT	16V 22µF
C2425	ECUV1H103KBX S.M. CAP	50V 10nF
C2426	ECUV1H101JCX S.M. CAP	50V 100pF
C2429	ECUV1H101JCX S.M. CAP	50V 100pF
C2432	ECUV1H561JCX S.M. CAP	50V 560pF
C2433	ECUV1H561JCX S.M. CAP	50V 560pF
C2434	ECUV1H561JCX S.M. CAP	50V 560pF
C2435	ECUV1H561JCX S.M. CAP	50V 560pF
C2436	ECUV1H561JCX S.M. CAP	50V 560pF
C2437	ECA1HM100GB ELECT	50V 10µF
C2438	ECA1HM010GB ELECT	50V 1µF
C2439	ECA1HM010GB ELECT	50V 1µF
C2440	ECA1HM100GB ELECT	50V 10µF
C2441	ECUV1H393KBX S.M. CAP	50V 39nF
C2442	ECUV1H393KBX S.M. CAP	50V 39nF
C2443	ECUV1H050CCX S.M. CAP	50V 5pF
C2444	ECUV1H393KBX S.M. CAP	50V 39nF
C2445	ECEA1HN010UB ELECT	50V 1µF
C2446	ECEA1HN010UB ELECT	50V 1µF
C2449	ECA1HM100GB ELECT	50V 10µF
C2450	ECUV1H222KBX S.M. CAP	50V 2.2nF
C2451	ECA1HM010GB ELECT	50V 1µF
C2455	ECA1HM010GB ELECT	50V 1µF
C2456	ECA1HM330B ELECT	50V 33µF
C2459	ECA1HM010GB ELECT	50V 1µF
C2460	ECA1HM010GB ELECT	50V 1µF
C2461	ECA1HM100GB ELECT	50V 10µF
C2464	ECA1HM0R1B ELECT	50V R1µF
C2467	ECA1HM0R1B ELECT	50V R1µF
C2468	ECA1HM010GB ELECT	50V 1µF

Ref No.	Part No.	Description	
C2469	ECA1HM010GB	ELECT	50V 1μF
C2470	ECA1HM100GB	ELECT	50V 10μF
C2471	ECA1HM101GB	ELECT	50V 100μF
C2472	ECA1HM100GB	ELECT	50V 10μF
C2473	ECUV1H103ZFX	S.M. CAP	50V 10nF
C2474	ECUV1H103ZFX	S.M. CAP	50V 10nF
C2475	ECUV1H330JCX	S.M. CAP	50V 33pF
C2476	ECUV1H330JCX	S.M. CAP	50V 33pF
C2477	ERJ6GEYJ682	S.M.CARB	0.1W 5% 6K8Ω
C2478	ECA1HM220GB	ELECT	50V 22μF
C2479	ECEA1HN010UB	ELECT	50V 1μF
C2480	ECEA1HN010UB	ELECT	50V 1μF
C2481	ECEA1HN010UB	ELECT	50V 1μF
C2482	ECEA1HN010UB	ELECT	50V 1μF
C2484	ECUV1H103KBX	S.M. CAP	50V 10nF
C2485	ECA1HMR22GB	ELECT	50V 0.22μF
C2486	ECUV1H103KBX	S.M. CAP	50V 10nF
C2487	ECA1HMR22GB	ELECT	50V 0.22μF
C2488	ECUV1H103KBX	S.M. CAP	50V 10nF
C2489	ECUV1H104ZFX	S.M. CAP	50V 100nF
C2490	ECEA1HU101	ELECT	50V 100μF
C2491	ECA1HM100GB	ELECT	50V 10μF
C2492	ECUV1H103KBX	S.M. CAP	50V 10nF
C2493	ECA1HMR22GB	ELECT	50V 0.22μF
C2494	ECA1HM4R7GB	ELECT	50V 4.7μF
C2495	ECA1HM100GB	ELECT	50V 10μF
C2502	ECOS2GA101BB	ELECT	400V 100μF
C2504	ECKC3D471JB	CERAMIC	2KV 470pF Δ
C2505	ECKC2H103J	CERAMIC	500V 10nF Δ
C2506	ECQM1H333J	FILM	50V 33nF
C2507	ECQM1H683J	FILM	50V 68nF
C2508	ECA1CM221GB	ELECT	16V 220μF
C2509	ECA1CM221GB	ELECT	16V 220μF
C2510	ECKWNA102MBO	CERAMIC	1nF
C2511	ECA1EM221GB	ELECT	25V 220μF
C2512	ECA1CM102B	ELECT	16V 1μF
C2513	ECA1HM010GB	ELECT	50V 1μF
C2514	ECA1HM010GB	ELECT	50V 1μF
C2517	ECKC2H471J	CERAMIC	500V 470pF Δ
C2518	ECA1EM101GB	ELECT	25V 1μF
C2520	ECEA1HU471	ELECT	50V 470μF
C2521	ECQM1H104J	FILM	50V 100nF
C2522	ECA1HM010GB	ELECT	50V 1μF
C2523	ECUV1H101JCX	S.M. CAP	50V 100pF
C2524	ECA1HM330B	ELECT	50V 33μF
C2525	ECUV1H103ZFX	S.M. CAP	50V 10nF
C2526	ECA1VM102GB	ELECT	35V 1000μF
C2527	ECUV1H222KBX	S.M. CAP	50V 2.2nF
C2528	ECA1VM102GB	ELECT	35V 1000μF
C2529	ECUV1H103ZFX	S.M. CAP	50V 10nF
C2530	ECUV1H683ZFX	S.M. CAP	50V 68nF
C2531	ECQM1H474J	FILM	50V 470nF
C2532	ECA1HM010GB	ELECT	50V 1μF
C2533	ECUV1H101JCX	S.M. CAP	50V 100pF
C2534	ECA1HM330B	ELECT	50V 33μF
C2535	ECUV1H103ZFX	S.M. CAP	50V 10nF
C2536	ECA1VM221B	ELECT	35V 220μF
C2537	ECUV1H222KBX	S.M. CAP	50V 2.2nF
C2538	ECA1VM101GB	ELECT	35V 100μF
C2539	ECUV1H103ZFX	S.M. CAP	50V 10nF
C2540	ECUV1H683ZFX	S.M. CAP	50V 68nF
C2541	ECQM1H474J	FILM	50V 470nF
C2542	ECUV1H332KBX	S.M. CAP	50V 3.3nF
C2543	ECUV1H332KBX	S.M. CAP	50V 3.3nF
C2544	ECUV1H223ZFX	S.M. CAP	50V 22nF
C2545	ECUV1H473ZFX	S.M. CAP	50V 47nF
C2546	ECA1CM221GB	ELECT	16V 220μF
C2547	ECA1HM100GB	ELECT	50V 10μF
C2548	ECA1HM100GB	ELECT	50V 10μF
C2549	ECA1HM100GB	ELECT	50V 10μF
C2550	ECA1HM100GB	ELECT	50V 10μF
C2551	ECA1CM221GB	ELECT	16V 220μF
C2552	ECA1HM010GB	ELECT	50V 1μF
C2553	ECA1HM010GB	ELECT	50V 1μF
C2554	ECUV1H104ZFX	S.M. CAP	50V 100nF
C2555	ECUV1H104ZFX	S.M. CAP	50V 100nF
C2556	ECA1HMR47GB	ELECT	50V 0.47μF
C2557	ECA1HM4R7GB	ELECT	50V 4.7μF
C2558	ECA1HMR47GB	ELECT	50V 0.47μF
C2559	ECA1HM4R7GB	ELECT	50V 4.7μF
C2560	ECUV1C154KBX	S.M. CAP	16V 150nF
C2561	ECA1HM3R3GB	ELECT	50V 3.3μF

Ref No.	Part No.	Description	
C2562	ECUV1C154KBX	S.M. CAP	16V 150nF
C2563	ECUV1C154KBX	S.M. CAP	16V 150nF
C2564	ECA1HM3R3GB	ELECT	50V 3.3μF
C2565	ECUV1C154KBX	S.M. CAP	16V 150nF
C2566	ECA1HM4R7GB	ELECT	50V 4.7μF
C2567	ECA1HMR47GB	ELECT	50V 0.47μF
C2568	ECA1HM4R7GB	ELECT	50V 4.7μF
C2569	ECA1HMR47GB	ELECT	50V 0.47μF
C2570	ECUV1H104ZFX	S.M. CAP	50V 100nF
C2571	ECUV1H104ZFX	S.M. CAP	50V 100nF
C2572	ECA1HM470GB	ELECT	50V 47μF
C2573	ECQM1H474J	FILM	50V 470nF
C2574	ECUV1H681JCX	S.M. CAP	50V 680pF
C2575	ECA1HM010GB	ELECT	50V 1μF
C2576	ECA1HM010GB	ELECT	50V 1μF
C2577	ECA1CM221GB	ELECT	16V 220μF
C2578	ECA1HM2R2GB	ELECT	50V 2.2μF
C2579	ECUV1H103ZFX	S.M. CAP	50V 10nF
C2580	ECEA1HN010UB	ELECT	50V 1μF
C2581	ECA1HM100GB	ELECT	50V 10μF
C2582	ECUV1H103ZFX	S.M. CAP	50V 10nF
C2583	ECA1CM221GB	ELECT	16V 220μF
C2584	ECA1HM010GB	ELECT	50V 1μF
C2585	ECUV1H333KBX	S.M. CAP	50V 33nF
C2586	ECUV1H152JCX	S.M. CAP	50V 1.5pF
C2587	ECUV1H333KBX	S.M. CAP	50V 33nF
C2588	ECA1CM221GB	ELECT	16V 220μF
C2589	ECUV1H330JCX	S.M. CAP	50V 33pF
C2590	ECUV1H330JCX	S.M. CAP	50V 33pF
C2591	ECEA1HN010UB	ELECT	50V 1μF
C2594	ECEA1HN010UB	ELECT	50V 1μF
C2595	ECEA1HN010UB	ELECT	50V 1μF
C2596	ECUV1H103ZFX	S.M. CAP	50V 10nF
C2597	ECA1CM471GB	ELECT	16V 470μF
C2700	ECUV1H102KBX	S.M. CAP	50V 1nF
C2701	ECA1HM010GB	ELECT	50V 1μF
C2702	ECA1CM470GB	ELECT	16V 47μF
C2703	ECEA1HN010UB	ELECT	50V 1μF
C2704	ECA1HM010GB	ELECT	50V 1μF
C2705	ECUV1H101JCX	S.M. CAP	50V 100pF
C2706	ECUV1H101JCX	S.M. CAP	50V 100pF
C2707	ECUV1H101JCX	S.M. CAP	50V 100pF
C2708	ECA1HM010GB	ELECT	50V 1μF
C2801	ECA1HM010GB	ELECT	50V 1μF
C2802	ECA1HM010GB	ELECT	50V 1μF
C2803	ECA1HM010GB	ELECT	50V 1μF
C2804	ECA1HM010GB	ELECT	50V 1μF
C2805	ECA1CM100GB	ELECT	16V 10μF
C2806	ECA1HM010GB	ELECT	50V 1μF
C2807	ECUV1H222KBX	S.M. CAP	50V 2.2nF
C2808	ECA1HM010GB	ELECT	50V 1μF
C2809	ECUV1H222KBX	S.M. CAP	50V 2.2nF
C2810	ECA1HM010GB	ELECT	50V 1μF
C2811	ECUV1H222KBX	S.M. CAP	50V 2.2nF
C2812	ECA1HM010GB	ELECT	50V 1μF
C2813	ECUV1H222KBX	S.M. CAP	50V 2.2nF
C2814	ECA1HM100GB	ELECT	50V 10μF
C2815	ECA1CM471GB	ELECT	16V 470μF
C3001	ECKC1H561J	CERAMIC	50V 560pF
C3002	ECKC1H561J	CERAMIC	50V 560pF
C3101	ECEA1HN4R7UB	ELECT	50V 4.7μF
C3105	ECUV1H561JCX	S.M. CAP	50V 560pF
C3109	ECUV1H561JCX	S.M. CAP	50V 560pF
C3111	ECUV1H102JCX	S.M. CAP	50V 1nF
C3112	ECA1HM470GB	ELECT	50V 47μF
C3113	ECA1HM470GB	ELECT	50V 47μF
C3114	ECA1CM470GB	ELECT	16V 47μF
C3115	ECEA1HNR47UB	ELECT	50V 0.47μF
C3116	ECA1HM470GB	ELECT	50V 47μF
C3117	ECEA1HN4R7UB	ELECT	50V 4.7μF
C3118	ECEA1HN4R7UB	ELECT	50V 4.7μF
C3119	ECA1HM470GB	ELECT	50V 47μF
C3120	ECA1CM470GB	ELECT	16V 47μF
C3121	ECUV1H561JCX	S.M. CAP	50V 560pF
C3123	ECEA1HN4R7UB	ELECT	50V 4.7μF
C3124	ECUV1H561JCX	S.M. CAP	50V 560pF
C3126	ECEA1HN4R7UB	ELECT	50V 4.7μF
C3127	ECEA1HN4R7UB	ELECT	50V 4.7μF
C3128	ECEA1HN4R7UB	ELECT	50V 4.7μF
C3129	ECUV1H102JCX	S.M. CAP	50V 1nF
C3130	ECEA1HN4R7UB	ELECT	50V 4.7μF
C3131	ECUV1H473KBX	S.M. CAP	50V 47nF

Ref No.	Part No.	Description
C3132	ECA1CM470GB	ELECT 16V 47µF
C3133	ECA1CM470GB	ELECT 16V 47µF
C3134	ECA1CM470GB	ELECT 16V 47µF
C3135	ECA1HMR47GB	ELECT 50V 0.47µF
C3136	ECA1CM470GB	ELECT 16V 47µF
C3137	ECA1HM470GB	ELECT 50V 47µF
C3138	ECA1HM470GB	ELECT 50V 47µF
C3143	ECUV1H561JCX	S.M. CAP 50V 560pF
C3146	ECUV1H561JCX	S.M. CAP 50V 560pF
C3148	ECA1HM4R7GB	ELECT 50V 4.7µF
C3149	ECUV1H561JCX	S.M. CAP 50V 560pF
C3150	ECA1HM4R7GB	ELECT 50V 4.7µF
C3151	ECUV1H561JCX	S.M. CAP 50V 560pF
C3153	ECUV1H104ZFX	S.M. CAP 50V 100nF
C3154	ECUV1H104ZFX	S.M. CAP 50V 100nF
C3155	ECA1CM470GB	ELECT 16V 47µF
C3156	ECA1CM470GB	ELECT 16V 47µF
C3158	ECUV1H102JCX	S.M. CAP 50V 1nF
C3159	ECUV1H121JCX	S.M. CAP 50V 120pF
C3160	ECUV1H104ZFX	S.M. CAP 50V 100nF
C3162	ECA1CM471GB	ELECT 16V 470µF
C3163	ECA1HMR47GB	ELECT 50V 0.47µF
C3164	ECUV1H104ZFX	S.M. CAP 50V 100nF
C3165	ECA1HM470GB	ELECT 50V 47µF
C3169	ECUV1H102JCX	S.M. CAP 50V 1nF
C3170	ECUV1H561JCX	S.M. CAP 50V 560pF
C3172	ECUV1H561JCX	S.M. CAP 50V 560pF
C3173	ECA1HMR47GB	ELECT 50V 0.47µF
C3174	ECUV1H561JCX	S.M. CAP 50V 560pF
C3178	ECUV1H561JCX	S.M. CAP 50V 560pF
C3180	ECA1HMR47GB	ELECT 50V 0.47µF
C3181	ERJ6GEY0R00	S.M.CARB 0.1W 5% 0Ω
C3182	ECUV1H102JCX	S.M. CAP 50V 1nF
C3183	ERJ6GEY0R00	S.M.CARB 0.1W 5% 0Ω
C3184	ECUV1H473KBX	S.M. CAP 50V 47nF
C3185	ERJ6GEY0R00	S.M.CARB 0.1W 5% 0Ω
C3186	ECEA1HNR47UB	ELECT 50V 0.47µF
C3187	ECA1HM470GB	ELECT 50V 47µF
C3188	ECEA1CN470	ELECT 16V 47µF
C3189	ECEA1CN470	ELECT 16V 47µF
C3190	ECA1HMR47GB	ELECT 50V 0.47µF
C3191	ECA1HM470GB	ELECT 50V 47µF
C3192	ECUV1H473KBX	S.M. CAP 50V 47nF
C3193	ECUV1H473KBX	S.M. CAP 50V 47nF
C3194	ECA1HM470GB	ELECT 50V 47µF
C3195	ECUV1H391JCX	S.M. CAP 50V 390pF
C3196	ECEA1CN330	ELECT 16V 33µF
C3201	ECA1HM010GB	ELECT 50V 1µF
C3202	ECUV1H473ZFX	S.M. CAP 50V 47nF
C3203	ECA1CM100GB	ELECT 16V 10µF
C3204	ECUV1H473ZFX	S.M. CAP 50V 47nF
C3351	ECA1HM101GB	ELECT 50V 100µF
C3501	ECUV1H220JCX	S.M. CAP 50V 22pF
C3502	ECUV1H220JCX	S.M. CAP 50V 22pF
C3503	ECEA1HKN010	ELECT 50V 1µF
C3504	ECUV1H224ZFX	S.M. CAP 50V 220nF
C3510	ECUV1H103ZFX	S.M. CAP 50V 10nF
C3511	ECA1HM101GB	ELECT 50V 100µF
C3512	ECUV1H104ZFX	S.M. CAP 50V 100nF
C3514	ECUV1H104ZFX	S.M. CAP 50V 100nF
C3515	ECA0JM331GB	ELECT 6.3V 330pF
C3516	ECUV1H104ZFX	S.M. CAP 50V 100nF
C3521	ECA1HM101GB	ELECT 50V 100µF
C3522	ECUV1H104ZFX	S.M. CAP 50V 100nF
C3801	ECA1HM010GB	ELECT 50V 1µF
C3802	ECUV1H104ZFX	S.M. CAP 50V 100nF
C3803	ECA1CM471GB	ELECT 16V 470µF
C3807	ECUV1H104ZFX	S.M. CAP 50V 100nF
C3808	ECUV1H104ZFX	S.M. CAP 50V 100nF
C3809	ECA0JM101G	ELECT 6.3V 100µF
C3810	ECUV1H103KBX	S.M. CAP 50V 10nF
C3812	ECA1CM221GB	ELECT 16V 220µF

DIODES

D001	MA4020	DIODE
D251	MA165TA5	DIODE 1SS133T-77
D252	MA165TA5	DIODE 1SS133T-77
D253	MA165TA5	DIODE 1SS133T-77
D254	MA165TA5	DIODE 1SS133T-77
D351	ERA15-04V3	COIL

Ref No.	Part No.	Description
D352	ERA15-04V3	COIL
D361	ERA15-04V3	COIL
D362	ERA15-04V3	COIL
D371	ERA15-04V3	COIL
D372	ERA15-04V3	COIL
D373	MTZJT-7715A	DIODE
D387	MA2160LFS	DIODE
D401	MA167TA5	DIODE
D451	MA4056	DIODE
D452	MA2330-ALF	DIODE
D453	TVSEM01ZV0	DIODE
D457	1SS252T-77	DIODE
D502	1SS254T-77	DIODE
D503	EU02	DIODE
D504	EU02	DIODE
D531	1SS254T-77	DIODE
D532	1SS254T-77	DIODE
D533	1SS254T-77	DIODE
D551	EU02	DIODE
D556	AU02V0	DIODE
D557	ERC91-02L9	DIODE
D558	AU02V0	DIODE
D559	MTZJT-7736A	DIODE
D560	1SS252T-77	DIODE
D561	1SS254T-77	DIODE
D563	RH3GLF102	DIODE
D571	FMV-3GULF027	DIODE
D572	RU3NLF1A	DIODE
D573	1SS254T-77	DIODE
D574	1SS252T-77	DIODE
D575	1SS252T-77	DIODE
D602	MA165TA5	DIODE 1SS133T-77
D603	MA165TA5	DIODE 1SS133T-77
D604	MA4062	DIODE
D706	MA165TA5	DIODE 1SS133T-77
D707	MA188TA	DIODE
D803	MTZJT-7711C	DIODE
D806	TF361MALF3	DIODE
D807	RBV-608LF-B	DIODE
D808	1SS254T-77	DIODE
D809	ERA22-02V3	DIODE
D810	MA2160LFS	DIODE
D812	MTZJT-775.6B	DIODE
D813	MA700TA5	DIODE
D814	AU01ZV0	DIODE
D815	PC123FY2	DIODE
D817	D5L60F4015	DIODE
D818	TMPG10G3	DIODE
D819	ERA81004V3	COIL
D820	MA4100	DIODE
D821	EU02AV0	DIODE
D822	MTZJT-7718C	DIODE
D845	1SS254T-77	DIODE
D846	TVSS1WBS20	DIODE
D847	ERA15-01V1	DIODE
D848	EU02	DIODE
D849	FMGG26S	DIODE
D850	EU02	DIODE
D851	FMGG2CS	DIODE
D852	MTZJT-779.1C	DIODE
D853	1SS254T-77	DIODE
D854	1SS254T-77	DIODE
D855	D10SC6MRL	DIODE
D857	FML22SLF610	DIODE
D860	1SS254T-77	DIODE
D861	MTZJT-7713B	DIODE
D901	1SS254T-77	DIODE
D902	1SS254T-77	DIODE
D903	1SS254T-77	DIODE
D1051	LN81RPHL	DIODE
D1052	AU01V0	DIODE
D1053	AU01V0	DIODE
D1054	AU01V0	DIODE
D1055	AU01V0	DIODE
D1056	AU01V0	DIODE
D1057	AU01V0	DIODE
D1102	MA4051	DIODE
D1107	MTZJT-775.6A	DIODE
D1108	1SS254T-77	DIODE
D1109	1SS254T-77	DIODE

Ref No.	Part No.	Description
D1113	MA4051	DIODE
D1552	RLS72TE-11	DIODE OR PMLL4148
D1824	MA4051	DIODE
D2003	MA4091	DIODE
D2004	MA165TA5	DIODE 1SS133T-77
D2005	MA723TA5	DIODE
D2006	MA723TA5	DIODE
D2007	MA165TA5	DIODE 1SS133T-77
D2008	MA165TA5	DIODE 1SS133T-77
D2421	RLS73TE-11	COIL
D2422	RLS73TE-11	COIL
D2480	RLS73TE-11	COIL
D2501	D5L60F4015	DIODE
D2502	EG01CV0	DIODE
D2503	EU02	DIODE
D2504	TVSEH1V0	DIODE
D2505	MA4075	DIODE
D2506	EU02	DIODE
D2507	EU02	DIODE
D2510	EU02	DIODE
D2511	RU4AMLF-M1	DIODE
D2512	RLS73TE-11	COIL
D2513	1SS254T-77	DIODE
D2514	RLS73TE-11	COIL
D2515	RLS73TE-11	COIL
D2517	1SS254T-77	DIODE
D2518	1SS254T-77	DIODE
D2519	1SS254T-77	DIODE
D2520	1SS254T-77	DIODE
D2521	1SS254T-77	DIODE
D2522	1SS254T-77	DIODE
D2523	1SS254T-77	DIODE
D2524	MTZJT-7712C	DIODE
D2525	MTZJT-7712C	DIODE
D2526	MTZJT-7712C	DIODE
D2527	MTZJT-7712C	DIODE
D2528	UDZTE-1712B	DIODE
D2529	RLS73TE-11	COIL
D2530	RLS73TE-11	COIL
D2531	RLS73TE-11	COIL
D2801	RLS73TE-11	COIL
D3101	PMLL5242B	DIODE
D3104	PMLL5242B	DIODE
D3105	PMLL5242B	DIODE
D3107	PMLL5242B	DIODE
D3108	PMLL5242B	DIODE
D3109	PMLL5242B	DIODE
D3110	PMLL5242B	DIODE
D3111	PMLL5242B	DIODE
D3112	PMLL5242B	DIODE
D3115	PMLL5242B	DIODE
D3117	PMLL5242B	DIODE
D3120	RLS72TE-11	DIODE OR PMLL4148
D3121	RLS72TE-11	DIODE OR PMLL4148
D3351	1SS254T-77	DIODE
D3501	MA4030	DIODE
D3801	MA4043	DIODE
D3802	MTZJT-778.2A	DIODE
D3803	ERA81004V3	COIL
D3805	MA4091	DIODE
D3806	MA165TA5	DIODE 1SS133T-77
D3807	MA165TA5	DIODE 1SS133T-77

FUSES

F531	TR5-T1000	FUSE	△
F801	XBA2C50TH15	FUSE	
F845	TR5-T2000	FUSE	△
F846	TR5-T1250	FUSE	△
F8011	EYF52BC	FUSE HOLDER	
F8012	EYF52BC	FUSE HOLDER	

INTEGRATED CIRCUITS

IC101	LA7577N	V.I.F.
IC251	TDA2030AV	AUDIO AMPLIFIER
IC252	TDA2030AV	AUDIO AMPLIFIER
IC351	TDA6111	RGB OUTPUT
IC361	TDA6111	RGB OUTPUT

Ref No.	Part No.	Description
IC371	TDA6111	RGB OUTPUT
IC401	TDA9151-B	DEFLECTION CONTROL
IC451	TDA8350Q/N5	VERTICAL OUTPUT
IC601	TDA9143-N1	COLOUR DECODER
IC602	TDA4665-V4	DELAY LINE
IC603	TDA4780	RGB VIDEO PROCESSOR
IC801	AN8029	POWER SUPPLY I.C.
IC845	SE140N	ERROR AMPLIFIER
IC851	TL431ACLPM	COIL
IC852	TL431ACLPM	COIL
IC1051	RPM-637CBRS1	LED RECEIVER
IC1101	SDA30C164-2	MICRO PROCESSOR
IC1102	S-80745AL-Z	RESET
IC1103	MN1280R	RESET
IC1104	X24C0302AQ	EAROM
IC1105	27C2001204AA	EPROM
IC1301	SA44961	COMB FILTER
IC1551	SN74F04DR	CLOCK BUFFER
IC1552	SDA9257	CLOCK GENERATOR
IC1581	SDA9205-2GEG	A/D CONVERTER
IC1601	UPD93213GF	DFU
IC1602	SDA9280GEG	VISUAL PROCESSOR
IC1701	MB87D202A	VIDEO PROCESSOR
IC1721	SDA9251-2XGE	RAM
IC1722	SDA9251-2XGE	RAM
IC1723	SDA9251-2XGE	RAM
IC1724	SDA9251-2XGE	RAM
IC1725	SDA9251-2XGE	RAM
IC1726	SDA9251-2XGE	RAM
IC1727	SDA9251-2XGE	RAM
IC1801	TDA9143-N1	COLOUR DECODER
IC1802	TDA4665-V4	DELAY LINE
IC1803	SDA9187-2XGE	A/D CONVERTER
IC1841	SDA9189XGEG	PIP PROCESSOR
IC1844	L78M05MRB	5V REGULATOR
IC1901	LA6515	EARTH CORRECTION
IC2001	MS P3410BPPF7	AUDIO PROCESSOR
IC2501	STR10006-M	SWITCHABLE POWER SUPPLY
IC2502	L78M12MRB	12V REGULATOR
IC2503	L78M05MRB	5V REGULATOR
IC2505	TDA2030AV	AUDIO AMPLIFIER
IC2506	TDA2030AV	AUDIO AMPLIFIER
IC2507	LA2785	DOLBY ENCODER
IC2508	AN7809FLB	9V REGULATOR
IC2509	LV1011	DOLBY MATRIX
IC2511	AN5295K	AUDIO CONTROL
IC2512	M5222P	SURROUND VOLUME CONTROL
IC2513	SC442138CB	MICRO PROCESSOR
IC2514	MN1280R	RESET
IC2515	AN6554	OPERATIONAL AMPLIFIER
IC2516	AN6554	OPERATIONAL AMPLIFIER
IC2517	TDA2030AV	AUDIO AMPLIFIER
IC2518	AN6554	OPERATIONAL AMPLIFIER
IC2801	AN6554NSF-E2	OPERATIONAL AMPLIFIER
IC3101	TEA6420	AUDIO SWITCH
IC3102	TEA6415C	VIDEO SWITCH
IC3501	SDA5273S/134	MEGA TEXT
IC3502	M514256B70RS	DRAM
IC3801	AN7808LB	8V REGULATOR
IC3803	AN7805LB	5V REGULATOR
IC3804	AN7809FLB	9V REGULATOR
IC3805	AN78L08TA	8V REGULATOR

TERMINALS AND LINKS

J1	ERDS2TY0T	RESISTOR		0Ω	
J2	ERDS2TY0T	RESISTOR		0Ω	
JA1	ERJ6GEY0R00	S.M.CARB	0.1W	5%	0Ω
JA10	ERJ6GEY0R00	S.M.CARB	0.1W	5%	0Ω
JA2	ERJ6GEY0R00	S.M.CARB	0.1W	5%	0Ω
JA3	ERJ6GEY0R00	S.M.CARB	0.1W	5%	0Ω
JA4	ERJ6GEY0R00	S.M.CARB	0.1W	5%	0Ω
JA5	ERJ6GEY0R00	S.M.CARB	0.1W	5%	0Ω
JA6	ERJ6GEY0R00	S.M.CARB	0.1W	5%	0Ω
JA7	ERJ6GEY0R00	S.M.CARB	0.1W	5%	0Ω
JA8	ERJ6GEY0R00	S.M.CARB	0.1W	5%	0Ω
JA9	ERJ6GEY0R00	S.M.CARB	0.1W	5%	0Ω
JC1	ERJ6GEY0R00	S.M.CARB	0.1W	5%	0Ω
JC2	ERJ6GEY0R00	S.M.CARB	0.1W	5%	0Ω

Ref No.	Part No.	Description			
JC3	ERJ6GEY0R00	S.M.CARB 0.1W	5%	0Ω	
JK2501	TJB8E013	6 PIN PUSH TERMINAL			
JK2502	TJB8E015	RCA TERMINAL (3P)			
JK2503	TJB8E014	RCA TERMINAL (2P)			
JK3001	TJB16656	A.V. TERMINAL			
JS E012	ERJ6GEY0R00	S.M.CARB 0.1W	5%	0Ω	
JS E015	ERJ6GEY0R00	S.M.CARB 0.1W	5%	0Ω	
JS E018	ERJ6GEY0R00	S.M.CARB 0.1W	5%	0Ω	
JS E019	ERJ6GEY0R00	S.M.CARB 0.1W	5%	0Ω	
JS E02	ERJ6GEY0R00	S.M.CARB 0.1W	5%	0Ω	
JS E020	ERJ6GEY0R00	S.M.CARB 0.1W	5%	0Ω	
JS E021	ERJ6GEY0R00	S.M.CARB 0.1W	5%	0Ω	
JS E022	ERJ6GEY0R00	S.M.CARB 0.1W	5%	0Ω	
JS E023	ERJ6GEY0R00	S.M.CARB 0.1W	5%	0Ω	
JS E024	ERJ6GEY0R00	S.M.CARB 0.1W	5%	0Ω	
JS E025	ERJ6GEY0R00	S.M.CARB 0.1W	5%	0Ω	
JS E028	ERJ6GEY0R00	S.M.CARB 0.1W	5%	0Ω	
JS E042	ERJ6GEY0R00	S.M.CARB 0.1W	5%	0Ω	
JS E050	ERJ6GEY0R00	S.M.CARB 0.1W	5%	0Ω	
JS E056	ERJ6GEY0R00	S.M.CARB 0.1W	5%	0Ω	
JS E057	ERJ6GEY0R00	S.M.CARB 0.1W	5%	0Ω	
JS E058	ERJ6GEY0R00	S.M.CARB 0.1W	5%	0Ω	
JS E062	ERJ6GEY0R00	S.M.CARB 0.1W	5%	0Ω	
JS E064	ERJ6GEY0R00	S.M.CARB 0.1W	5%	0Ω	
JS E09	ERJ6GEY0R00	S.M.CARB 0.1W	5%	0Ω	
JS F001	ERJ6GEY0R00	S.M.CARB 0.1W	5%	0Ω	
JS F002	ERJ6GEY0R00	S.M.CARB 0.1W	5%	0Ω	
JS F004	ERJ6GEY0R00	S.M.CARB 0.1W	5%	0Ω	
JS F005	ERJ6GEY0R00	S.M.CARB 0.1W	5%	0Ω	
JS F015	ERJ6GEY0R00	S.M.CARB 0.1W	5%	0Ω	
JS F026	ERJ6GEY0R00	S.M.CARB 0.1W	5%	0Ω	
JS F038	ERJ6GEY0R00	S.M.CARB 0.1W	5%	0Ω	
JS F040	ERJ6GEY0R00	S.M.CARB 0.1W	5%	0Ω	
JS F041	ERJ6GEY0R00	S.M.CARB 0.1W	5%	0Ω	
JS F045	ERJ6GEY0R00	S.M.CARB 0.1W	5%	0Ω	
JS F046	ERJ6GEY0R00	S.M.CARB 0.1W	5%	0Ω	
JS F049	ERJ6GEY0R00	S.M.CARB 0.1W	5%	0Ω	
JS F050	ERJ6GEY0R00	S.M.CARB 0.1W	5%	0Ω	
JS F054	ERJ6GEY0R00	S.M.CARB 0.1W	5%	0Ω	
JS F056	ERJ6GEY0R00	S.M.CARB 0.1W	5%	0Ω	
JS F059	ERJ6GEY0R00	S.M.CARB 0.1W	5%	0Ω	
JS F061	ERJ6GEY0R00	S.M.CARB 0.1W	5%	0Ω	
JS F062	ERJ6GEY0R00	S.M.CARB 0.1W	5%	0Ω	
JS G001	ERJ6GEY0R00	S.M.CARB 0.1W	5%	0Ω	
JS G002	ERJ6GEY0R00	S.M.CARB 0.1W	5%	0Ω	
JS G011	ERJ6GEY0R00	S.M.CARB 0.1W	5%	0Ω	
JS G024	ERJ6GEY0R00	S.M.CARB 0.1W	5%	0Ω	
JS G025	ERJ6GEY0R00	S.M.CARB 0.1W	5%	0Ω	
JS G026	ERJ6GEY0R00	S.M.CARB 0.1W	5%	0Ω	
JS G027	ERJ6GEY0R00	S.M.CARB 0.1W	5%	0Ω	
JS G028	ERJ6GEY0R00	S.M.CARB 0.1W	5%	0Ω	
JS G071	ERJ6GEY0R00	S.M.CARB 0.1W	5%	0Ω	
JS G073	ERJ6GEY0R00	S.M.CARB 0.1W	5%	0Ω	
JS G075	ERJ6GEY0R00	S.M.CARB 0.1W	5%	0Ω	
JS H01	ERJ6GEY0R00	S.M.CARB 0.1W	5%	0Ω	
JS H010	ERJ6GEY0R00	S.M.CARB 0.1W	5%	0Ω	
JS H02	ERJ6GEY0R00	S.M.CARB 0.1W	5%	0Ω	

COILS

L002	TLT047K991R	COIL
L004	TLT047K991R	COIL
L005	TLT047K991R	COIL
L101	ELESNR56MA	COIL
L104	ELESN6R8KA	COIL
L105	ELESN2R2KA	COIL
L106	EIV7EN201B	COIL
L107	EIV7EN200B	COIL
L252	EXCELSA35T	COIL
L253	EXCELSA35T	COIL
L254	EXCELSA35T	COIL
L255	EXCELSA35T	COIL
L351	SDL5000	DELAY LINE
L352	EXCELD25V	COIL
L353	TLT150K991R	COIL
L361	SDL5000	DELAY LINE
L362	EXCELD25V	COIL
L363	TLT150K991R	COIL
L371	SDL5000	DELAY LINE
L372	EXCELD25V	COIL
L373	TLT150K991R	COIL

Ref No.	Part No.	Description			
L381	TLT220K991R	COIL			
L401	EXCELD35V	COIL			
L402	EXCELD35V	COIL			
L451	EXCELD35V	COIL			
L552	EXCELSA35T	COIL			
L553	EXCELSA35T	COIL			
L554	EXCELD35V	COIL			
L555	EXCELD35C	COIL			
L571	ELC18B801L	COIL			
L572	ELHKLBO25B	COIL			
L573	ELHKLBO28B	COIL			
L575	ELC18B331E	COIL			
L576	ELC08D101E	COIL			
L601	TLT047K991R	COIL			
L602	TLT047K991R	COIL			
L603	TLT047K991R	COIL			
L605	ERD25TC0T	CARBON 0.25W	5%	0Ω	
L801	ELF18D486D	COIL			
L802	ELF18D486D	COIL			
L807	ELF18D856A	COIL			
L808	EXCELSA35T	COIL			
L809	EXCELD35C	COIL			
L810	EXCELSA39V	COIL			
L811	EXCELSA39V	COIL			
L812	EXCELD35V	COIL			
L813	EXCELD35V	COIL			
L817	EXCELD35V	COIL			
L845	EXCELSA35T	COIL			
L847	EXCELSA35B	COIL			
L848	EXCELSA35T	COIL			
L850	EXCELSA35T	COIL			
L851	EXCELSA35B	COIL			
L854	ELEIE150KA	COIL			
L856	EXCELSA35T	COIL			
L859	EXCELSA35T	COIL			
L860	EXCELSA35T	COIL			
L861	EXCELSA35T	COIL			
L862	EXCELSA35T	COIL			
L1102	EXCELD35V	COIL			
L1103	EXCELD35V	COIL			
L1104	EXCELSA35T	COIL			
L1105	ELEXT4R7KA	COIL			
L1301	TLT330K991R	COIL			
L1302	TLT100K991R	COIL			
L1303	TLT101K991R	COIL			
L1304	TLT100K991R	COIL			
L1306	TLT101K991R	COIL			
L1307	ERD25TC0T	CARBON 0.25W	5%	0Ω	
L1501	EXCELD35V	COIL			
L1502	TLT033K991R	COIL			
L1503	TLT033K991R	COIL			
L1504	TLT033K991R	COIL			
L1552	EXCELD35V	COIL			
L1553	EXCELD35V	COIL			
L1575	EXCELD35V	COIL			
L1576	EXCELD35V	COIL			
L1601	EXCELD35V	COIL			
L1602	EXCELD35V	COIL			
L1603	TLT100K991R	COIL			
L1604	TLT100K991R	COIL			
L1605	TLT100K991R	COIL			
L1606	TLT100K991R	COIL			
L1607	EXCELD35V	COIL			
L1641	EXCELD35V	COIL			
L1701	EXCELD35V	COIL			
L1721	EXCELD35V	COIL			
L1722	EXCELD35V	COIL			
L1801	TLT150K991R	COIL			
L1802	TLT150K991R	COIL			
L1803	ERDS2TY0T	RESISTOR			
L1804	EXCELD35V	COIL			
L1810	TLT470K991R	COIL			
L1812	TLT150K991R	COIL			
L1841	TLT150K991R	COIL			
L1842	TLT150K991R	COIL			
L1901	EXCELD25V	COIL			
L2001	TLT047K991R	COIL			
L2002	TLT100K991R	COIL			
L2003	EXCELD35V	COIL			

Ref No.	Part No.	Description
L2005	TLT068K991R	COIL
L2351	ELEBR6R8KA	COIL
L2361	ELEBR6R8KA	COIL
L2501	EXCELSA35T	COIL
L2502	EXCELSA35T	COIL
L2503	EXCELSA35T	COIL
L2504	EXCELSA35T	COIL
L2505	5770206400	COIL
L2506	5770206400	COIL
L2507	5770206400	COIL
L2508	ELESN100KA	COIL
L2509	ELESN100KA	COIL
L2510	ELESN100KA	COIL
L2511	EXCELSA35T	COIL
L2512	EXCELSA35T	COIL
L2513	EXCELSA35T	COIL
L2514	5770206400	COIL
L3001	ELEBR6R8KA	COIL
L3002	ELEBR6R8KA	COIL
L3003	ELEBR470KA	COIL
L3101	EXCELDR35V	COIL
L3102	EXCELDR35V	COIL
L3103	EXCELDR35V	COIL
L3104	EXCELDR35V	COIL
L3107	EXCELDR35V	COIL
L3108	EXCELDR35V	COIL
L3109	EXCELDR35V	COIL
L3110	EXCELDR35V	COIL
L3111	EXCELDR35V	COIL
L3112	EXCELDR35V	COIL
L3113	EXCELDR35V	COIL
L3114	EXCELDR35V	COIL
L3503	EXCELDR35V	COIL
L3507	EXCELDR35V	COIL
L3509	EXCELDR35V	COIL
L3511	TLT100K991R	COIL
LC1503	ELKTR391CA	DELAY LINE
LC1507	EXCEMT103DTM	COIL
LC1508	EXCEMT103DTM	COIL
LC1509	EXCEMT103DTM	COIL
LC1510	EXCEMT103DTM	COIL
LC1601	ELKTR391CA	DELAY LINE
LC1602	ELKTR391CA	DELAY LINE
LC1603	ELKTR391CA	DELAY LINE
LC1609	ELKTR560BA	DELAY LINE
LC1854	ELKTR391CA	DELAY LINE

TRANSISTORS

Q008	BC847B	TRANSISTOR	OR 2SD601ATX
Q101	BC847B	TRANSISTOR	OR 2SD601ATX
Q102	BF370-126	TRANSISTOR	
Q103	BC847B	TRANSISTOR	OR 2SD601ATX
Q104	BF370-126	TRANSISTOR	
Q105	BC847B	TRANSISTOR	OR 2SD601ATX
Q106	BC847B	TRANSISTOR	OR 2SD601ATX
Q109	BC860B	TRANSISTOR	
Q251	BC847B	TRANSISTOR	OR 2SD601ATX
Q252	BC847B	TRANSISTOR	OR 2SD601ATX
Q401	BC847B	TRANSISTOR	OR 2SD601ATX
Q502	2SC2925STA	TRANSISTOR	
Q531	BC547B	TRANSISTOR	
Q532	BC547B	TRANSISTOR	
Q533	BC547B	TRANSISTOR	
Q535	BC547B	TRANSISTOR	
Q551	BC547B	TRANSISTOR	
Q552	2SC5144LBMA1	TRANSISTOR	
Q553	2SC1473-RN	TRANSISTOR	
Q554	2SC1473-RN	TRANSISTOR	
Q572	BC547B	TRANSISTOR	
Q573	BC557B	TRANSISTOR	
Q574	2SD1265AOPLB	TRANSISTOR	
Q601	BC847B	TRANSISTOR	OR 2SD601ATX
Q602	BC857B	TRANSISTOR	OR 2SB709ATX
Q603	BC847B	TRANSISTOR	OR 2SD601ATX
Q604	BC857B	TRANSISTOR	OR 2SB709ATX
Q605	BC857B	TRANSISTOR	OR 2SB709ATX
Q607	BC847B	TRANSISTOR	OR 2SD601ATX
Q608	BC847B	TRANSISTOR	OR 2SD601ATX

Ref No.	Part No.	Description
Q609	BC847B	TRANSISTOR OR 2SD601ATX
Q610	BC847B	TRANSISTOR OR 2SD601ATX
Q611	BC847B	TRANSISTOR OR 2SD601ATX
Q612	BC847B	TRANSISTOR OR 2SD601ATX
Q801	2SK1489MAT	TRANSISTOR
Q803	2SD965-R	TRANSISTOR
Q804	2SA719-TA	TRANSISTOR
Q845	2SA684R	TRANSISTOR
Q846	BC547B	TRANSISTOR
Q847	BC557B	TRANSISTOR
Q848	BC547B	TRANSISTOR
Q849	2SA1018QTA	TRANSISTOR
Q850	2SD1474PLB	TRANSISTOR
Q851	BC547B	TRANSISTOR
Q852	BC547B	TRANSISTOR
Q901	BC847B	TRANSISTOR OR 2SD601ATX
Q902	BC847B	TRANSISTOR OR 2SD601ATX
Q903	BC847B	TRANSISTOR OR 2SD601ATX
Q904	BC857B	TRANSISTOR OR 2SB709ATX
Q905	BC847B	TRANSISTOR OR 2SD601ATX
Q906	BC847B	TRANSISTOR OR 2SD601ATX
Q907	BC857B	TRANSISTOR OR 2SB709ATX
Q908	2SA1535ARLB	TRANSISTOR
Q909	2SC3944ARLB	TRANSISTOR
Q1052	BC557B	TRANSISTOR
Q1101	BC847B	TRANSISTOR OR 2SD601ATX
Q1102	BC847B	TRANSISTOR OR 2SD601ATX
Q1103	BC847B	TRANSISTOR OR 2SD601ATX
Q1106	BC847B	TRANSISTOR OR 2SD601ATX
Q1107	BC847B	TRANSISTOR OR 2SD601ATX
Q1108	BC847B	TRANSISTOR OR 2SD601ATX
Q1112	2SC3757QRTX	TRANSISTOR
Q1191	BC847B	TRANSISTOR OR 2SD601ATX
Q1301	BC847B	TRANSISTOR OR 2SD601ATX
Q1303	BC847B	TRANSISTOR OR 2SD601ATX
Q1304	BC847B	TRANSISTOR OR 2SD601ATX
Q1501	BC847B	TRANSISTOR OR 2SD601ATX
Q1502	BC847B	TRANSISTOR OR 2SD601ATX
Q1503	BC847B	TRANSISTOR OR 2SD601ATX
Q1575	BC847B	TRANSISTOR OR 2SD601ATX
Q1642	BC847B	TRANSISTOR OR 2SD601ATX
Q1643	BC847B	TRANSISTOR OR 2SD601ATX
Q1644	BC857B	TRANSISTOR OR 2SB709ATX
Q1647	BC847B	TRANSISTOR OR 2SD601ATX
Q1648	BC857B	TRANSISTOR OR 2SB709ATX
Q1649	BC857B	TRANSISTOR OR 2SB709ATX
Q1803	BC847B	TRANSISTOR OR 2SD601ATX
Q1879	BC857B	TRANSISTOR OR 2SB709ATX
Q1880	BC857B	TRANSISTOR OR 2SB709ATX
Q1881	BC857B	TRANSISTOR OR 2SB709ATX
Q2001	BC860B	TRANSISTOR
Q2002	BC860B	TRANSISTOR
Q2003	BC860B	TRANSISTOR
Q2004	BC860B	TRANSISTOR
Q2005	BC857B	TRANSISTOR OR 2SB709ATX
Q2006	BC857B	TRANSISTOR OR 2SB709ATX
Q2351	BC547B	TRANSISTOR
Q2352	BC547B	TRANSISTOR
Q2353	BC557B	TRANSISTOR
Q2361	BC547B	TRANSISTOR
Q2362	BC547B	TRANSISTOR
Q2363	BC557B	TRANSISTOR
Q2480	BC847B	TRANSISTOR OR 2SD601ATX
Q2501	BC557B	TRANSISTOR
Q2502	2SA684R	TRANSISTOR
Q2504	BC847B	TRANSISTOR OR 2SD601ATX
Q2505	BC857B	TRANSISTOR OR 2SB709ATX
Q2506	BC847B	TRANSISTOR OR 2SD601ATX
Q2507	BC847B	TRANSISTOR OR 2SD601ATX
Q2508	BC857B	TRANSISTOR OR 2SB709ATX
Q2509	BC847B	TRANSISTOR OR 2SD601ATX
Q2510	BC857B	TRANSISTOR OR 2SB709ATX
Q2511	BC847B	TRANSISTOR OR 2SD601ATX
Q2512	BC857B	TRANSISTOR OR 2SB709ATX
Q2513	BC847B	TRANSISTOR OR 2SD601ATX
Q2514	BC847B	TRANSISTOR OR 2SD601ATX
Q2515	BC857B	TRANSISTOR OR 2SB709ATX
Q2516	BC847B	TRANSISTOR OR 2SD601ATX
Q2518	BC847B	TRANSISTOR OR 2SD601ATX

Ref No.	Part No.	Description
Q2801	BC847B	TRANSISTOR OR 2SD601ATX
Q3103	BC847B	TRANSISTOR OR 2SD601ATX
Q3104	BC847B	TRANSISTOR OR 2SD601ATX
Q3105	BC847B	TRANSISTOR OR 2SD601ATX
Q3106	BC847B	TRANSISTOR OR 2SD601ATX
Q3107	BC857B	TRANSISTOR OR 2SB709ATX
Q3108	BC847B	TRANSISTOR OR 2SD601ATX
Q3109	BC847B	TRANSISTOR OR 2SD601ATX
Q3110	BC847B	TRANSISTOR OR 2SD601ATX
Q3113	BC847B	TRANSISTOR OR 2SD601ATX
Q3114	BC847B	TRANSISTOR OR 2SD601ATX
Q3115	BC857B	TRANSISTOR OR 2SB709ATX
Q3201	BC847B	TRANSISTOR OR 2SD601ATX
Q3351	BC847B	TRANSISTOR OR 2SD601ATX
Q3352	BC857B	TRANSISTOR OR 2SB709ATX
Q3501	BC847B	TRANSISTOR OR 2SD601ATX
Q3502	BC847B	TRANSISTOR OR 2SD601ATX
Q3503	2SC3130TX	TRANSISTOR
Q3801	2SD1474PLB	TRANSISTOR
RL806	TSE1885-1	TRANSISTOR

RESISTORS

R003	ERJ6GEYJ223	S.M.CARB 0.1W	5%	22KΩ
R006	ERJ6GEYJ393	S.M.CARB 0.1W	5%	39KΩ
R011	ERJ6GEYJ101	S.M.CARB 0.1W	5%	100Ω
R012	ERJ6GEYJ101	S.M.CARB 0.1W	5%	100Ω
R101	ERJ6GEY0R00	S.M.CARB 0.1W	5%	0Ω
R102	ERJ6GEYJ103	S.M.CARB 0.1W	5%	10KΩ
R104	ERJ6GEYJ123	S.M.CARB 0.1W	5%	12KΩ
R105	ERJ6GEYJ272	S.M.CARB 0.1W	5%	2K7Ω
R108	ERJ6GEYJ471	S.M.CARB 0.1W	5%	470Ω
R110	ERJ6GEY0R00	S.M.CARB 0.1W	5%	0Ω
R111	ERJ6GEY0R00	S.M.CARB 0.1W	5%	0Ω
R112	ERJ6GEYJ103	S.M.CARB 0.1W	5%	10KΩ
R113	ERJ6GEYJ563	S.M.CARB 0.1W	5%	56KΩ
R114	ERJ6GEYJ103	S.M.CARB 0.1W	5%	10KΩ
R115	ERJ6GEYJ222	S.M.CARB 0.1W	5%	2K2Ω
R116	ERJ6GEY0R00	S.M.CARB 0.1W	5%	0Ω
R118	ERJ6GEYJ473	S.M.CARB 0.1W	5%	47KΩ
R119	ERJ6GEYJ102	S.M.CARB 0.1W	5%	1KΩ
R122	ERJ6GEYJ101	S.M.CARB 0.1W	5%	100Ω
R123	ERJ6GEYJ122	S.M.CARB 0.1W	5%	1K2Ω
R124	ERJ6GEYJ681	S.M.CARB 0.1W	5%	680Ω
R125	ERJ6GEYJ122	S.M.CARB 0.1W	5%	1K2Ω
R126	ERJ6GEY0R00	S.M.CARB 0.1W	5%	0Ω
R127	ERJ6GEYJ121	S.M.CARB 0.1W	5%	120Ω
R128	ERJ6GEYJ271	S.M.CARB 0.1W	5%	270Ω
R129	ERJ6GEYJ471	S.M.CARB 0.1W	5%	470Ω
R131	ERJ6GEYJ332	S.M.CARB 0.1W	5%	3K3Ω
R133	ERJ6GEY0R00	S.M.CARB 0.1W	5%	0Ω
R135	ERJ6GEYJ222	S.M.CARB 0.1W	5%	2K2Ω
R137	ERJ6GEYJ331	S.M.CARB 0.1W	5%	330Ω
R138	ERJ6GEYJ332	S.M.CARB 0.1W	5%	3K3Ω
R141	ERJ6GEY0R00	S.M.CARB 0.1W	5%	0Ω
R142	ERJ6GEYJ181	S.M.CARB 0.1W	5%	180Ω
R143	ERJ6GEYJ221	S.M.CARB 0.1W	5%	220Ω
R144	ERJ6GEYJ333	S.M.CARB 0.1W	5%	33KΩ
R145	ERJ6GEYJ102	S.M.CARB 0.1W	5%	1KΩ
R146	ERJ6GEYJ223	S.M.CARB 0.1W	5%	22KΩ
R147	ERJ6GEYJ153	S.M.CARB 0.1W	5%	15KΩ
R148	ERJ6GEYJ683	S.M.CARB 0.1W	5%	68KΩ
R149	ERJ6GEYJ103	S.M.CARB 0.1W	5%	10KΩ
R150	ERJ6GEY0R00	S.M.CARB 0.1W	5%	0Ω
R151	ERJ6GEY0R00	S.M.CARB 0.1W	5%	0Ω
R153	ERJ6GEYJ562	S.M.CARB 0.1W	5%	5K6Ω
R251	ERJ6GEYJ2R2	S.M.CARB0.125W	5%	2R2Ω
R252	ERJ6GEYJ183	S.M.CARB 0.1W	5%	18KΩ
R253	ERJ6GEYJ123	S.M.CARB 0.1W	5%	12KΩ
R254	ERJ6GEYJ223	S.M.CARB 0.1W	5%	22KΩ
R255	ERJ6GEYJ121	S.M.CARB 0.1W	5%	120Ω
R256	ERJ6GEYJ104	S.M.CARB 0.1W	5%	100KΩ
R257	ERJ6GEYJ102	S.M.CARB 0.1W	5%	1KΩ
R258	ERJ6GEYJ471	S.M.CARB 0.1W	5%	470Ω
R259	ERG3SJ102	METAL 3W	5%	1KΩ
R260	ERJ6GEYJ2R2	S.M.CARB0.125W	5%	2R2Ω
R261	ERJ6GEYJ183	S.M.CARB 0.1W	5%	18KΩ
R262	ERJ6GEYJ223	S.M.CARB 0.1W	5%	22KΩ
R263	ERJ6GEYJ121	S.M.CARB 0.1W	5%	120Ω

Ref No.	Part No.	Description		
R264	ERJ6GEYJ104	S.M.CARB 0.1W	5%	100KΩ
R265	ERJ6GEYJ471	S.M.CARB 0.1W	5%	470Ω
R266	ERJ6GEYJ102	S.M.CARB 0.1W	5%	1KΩ
R267	ERJ6GEYJ471	S.M.CARB 0.1W	5%	470Ω
R268	ERJ6GEYJ471	S.M.CARB 0.1W	5%	470Ω
R269	ERJ6GEYJ123	S.M.CARB 0.1W	5%	12KΩ
R270	ERG3SJ102	METAL 3W	5%	1KΩ
R351	ERJ6GEYJ102	S.M.CARB 0.1W	5%	1KΩ
R352	ERJ6GEYJ102	S.M.CARB 0.1W	5%	1KΩ
R354	ERJ6GEYJ102	S.M.CARB 0.1W	5%	1KΩ
R355	ERG2FJ823	METAL 2W	5%	82KΩ ▲
R356	ERJ6GEY0R00	S.M.CARB 0.1W	5%	0Ω
R357	ERJ6GEYJ822	S.M.CARB 0.1W	5%	8K2Ω
R358	ERDS1TJ821	CARBON 0.5W	5%	820Ω
R359	ERJ6GEYJ334	S.M.CARB 0.1W	5%	330KΩ
R360	ERDS1TJ103	CARBON 0.5W	5%	10KΩ
R361	ERJ6GEYJ102	S.M.CARB 0.1W	5%	1KΩ
R362	ERJ6GEYJ102	S.M.CARB 0.1W	5%	1KΩ
R364	ERJ6GEYJ102	S.M.CARB 0.1W	5%	1KΩ
R365	ERG2FJ823	METAL 2W	5%	82KΩ ▲
R366	ERJ6GEY0R00	S.M.CARB 0.1W	5%	0Ω
R367	ERJ6GEYJ822	S.M.CARB 0.1W	5%	8K2Ω
R368	ERDS1TJ821	CARBON 0.5W	5%	820Ω
R369	ERJ6GEY0R00	S.M.CARB 0.1W	5%	0Ω
R370	ERQ1CJP1R0	METAL 1W	5%	1R0Ω ▲
R370	ERQ1CKPR68	METAL 1W	5%	R68Ω ▲
R371	ERJ6GEYJ102	S.M.CARB 0.1W	5%	1KΩ
R372	ERJ6GEYJ102	S.M.CARB 0.1W	5%	1KΩ
R374	ERJ6GEYJ102	S.M.CARB 0.1W	5%	1KΩ
R375	ERG2FJ823	METAL 2W	5%	82KΩ ▲
R376	ERJ6GEY0R00	S.M.CARB 0.1W	5%	0Ω
R377	ERJ6GEYJ822	S.M.CARB 0.1W	5%	8K2Ω
R378	ERDS1TJ821	CARBON 0.5W	5%	820Ω
R379	ERJ6GEY0R00	S.M.CARB 0.1W	5%	0Ω
R380	ERJ6GEYJ222	S.M.CARB 0.1W	5%	2K2Ω
R381	ERJ6GEYJ561	S.M.CARB 0.1W	5%	560Ω
R383	ERJ6GEYJ562	S.M.CARB 0.1W	5%	5K6Ω
R384	ERQ12HJ101	FUSIBLE 0.5W	5%	100Ω ▲
R390	ERDS1TJ184	CARBON 0.5W	5%	180K
R401	ERJ6GEYJ153	S.M.CARB 0.1W	5%	15KΩ
R402	ERJ6GEYJ332	S.M.CARB 0.1W	5%	3K3Ω
R403	ERJ6GEYJ392	S.M.CARB 0.1W	5%	3K9Ω
R406	ERJ6GEYJ393	S.M.CARB 0.1W	5%	39KΩ
R407	ERJ6GEYJ101	S.M.CARB 0.1W	5%	100Ω
R408	ERJ6GEYJ101	S.M.CARB 0.1W	5%	100Ω
R409	ERJ6GEYJ102	S.M.CARB 0.1W	5%	1KΩ
R410	ERJ6GEYJ100	S.M.CARB 0.1W	5%	10Ω
R411	ERJ6GEYJ123	S.M.CARB 0.1W	5%	12KΩ
R412	ERJ6GEYJ103	S.M.CARB 0.1W	5%	10KΩ
R451	ERJ6GEYJ302	S.M.CARB 0.1W	5%	3K0Ω
R452	ERJ6GEYJ563	S.M.CARB 0.1W	5%	56KΩ
R453	ERG2FJ820	METAL 2W	5%	82Ω ▲
R454	ERX12SJ1R0	RESISTOR 12W	5%	1Ω
R455	ERX12SJ1R2	RESISTOR 12W	5%	1R2Ω
R456	ERDS1TJ220	CARBON 0.5W	5%	22Ω
R457	ERDS1TJ223	CARBON 0.5W	5%	22KΩ
R458	ERDS1TJ392	CARBON 0.5W	5%	3K9Ω
R459	ERJ6GEYJ393	S.M.CARB 0.1W	5%	39KΩ
R460	ERJ6GEYJ104	S.M.CARB 0.1W	5%	100KΩ
R461	ERJ6GEYJ184	S.M.CARB 0.1W	5%	180KΩ
R504	ERD25TJ271	CARBON 0.25W	5%	270Ω
R505	ERG3SJS330	METAL 3W	5%	33Ω
R506	ERDS1TJ152	CARBON 0.5W	5%	1K5Ω
R507	ERDS1TJ152	CARBON 0.5W	5%	1K5Ω
R531	ERD25TJ103	CARBON 0.25W	5%	10KΩ
R532	ERD25TJ103	CARBON 0.25W	5%	10KΩ
R533	ERD25TJ683	CARBON 0.25W	5%	68KΩ
R534	ERD25TJ473	CARBON 0.25W	5%	47KΩ
R535	ERD25TJ472	CARBON 0.25W	5%	4K7Ω
R536	ERD25TJ103	CARBON 0.25W	5%	10KΩ
R539	ERD25TJ103	CARBON 0.25W	5%	10KΩ
R540	ERD25TJ183	CARBON 0.25W	5%	18KΩ
R541	ERD25TJ102	CARBON 0.25W	5%	1KΩ
R542	ERD25TJ103	CARBON 0.25W	5%	10KΩ
R543	ERD25TJ222	CARBON 0.25W	5%	2K2Ω
R547	ERD25TJ103	CARBON 0.25W	5%	10KΩ
R551	ERD25TJ103	CARBON 0.25W	5%	10KΩ
R552	ERD25TJ473	CARBON 0.25W	5%	47KΩ
R553	ERD25TJ103	CARBON 0.25W	5%	10KΩ

Ref No.	Part No.	Description			
R554	ERX3SJSR27H	RESISTOR	3W	5%	R27Ω
R555	ERO25CKF2802	METAL	0.25W	1%	28KΩ ▲
R556	ERO50PKF2802	METAL	0.5W	1%	28KΩ ▲
R557	ERO25CKF6492	METAL	0.25W	1%	64R9KΩ ▲
R558	ERO50PKF4532	METAL	0.5W	1%	45R3KΩ ▲
R559	ERO25CKF1002	METAL	0.25W	1%	10KΩ ▲
R560	ERD25TJ222	CARBON	0.25W	5%	2K2Ω
R562	ERD25TJ473	CARBON	0.25W	5%	47KΩ
R564	ERDS1TJ394	CARBON	0.5W	5%	390KΩ
R565	ERQ14AJW2R2	FUSIBLE	14W	5%	2R2Ω ▲
R566	ERDS1TJ183	CARBON	0.5W	5%	18KΩ
R567	ERG2ANJ223	METAL	2W	5%	22KΩ
R568	ERQ12HJ330	METAL	0.5W	5%	33Ω ▲
R569	ERDS1TJ120	CARBON	0.5W	5%	12Ω
R570	ERD25TJ103	CARBON	0.25W	5%	10KΩ
R571	ERX3FJ2R7H	RESISTOR	3W	5%	2R7Ω
R572	ERG3FJ821	METAL	3W	5%	820Ω ▲
R574	ERG3FJ151	METAL	3W	5%	150Ω ▲
R577	ERD25TJ683	CARBON	0.25W	5%	68KΩ
R578	ERD25TJ153	CARBON	0.25W	5%	15KΩ
R579	ERD25TJ274	CARBON	0.25W	5%	270KΩ
R580	ERD25TJ563	CARBON	0.25W	5%	56KΩ
R581	ERD25TJ104	CARBON	0.25W	5%	100KΩ
R582	ERD25TJ225	CARBON	0.25W	5%	2M2Ω
R583	ERD25TJ225	CARBON	0.25W	5%	2M2Ω
R584	ERD25TJ152	CARBON	0.25W	5%	1K5Ω
R585	TSF19201	FS LINK			▲
R587	ERD25TJ222	CARBON	0.25W	5%	2K2Ω
R588	ERD25TJ222	CARBON	0.25W	5%	2K2Ω
R589	ERDS1TJ100	CARBON	0.5W	5%	10Ω
R591	ERF2AKR15	WIRE	2W	10%	R15Ω ▲
R601	ERJ6GEYJ101	S.M.CARB	0.1W	5%	100Ω
R602	ERJ6GEYJ101	S.M.CARB	0.1W	5%	100Ω
R603	ERJ6GEYJ102	S.M.CARB	0.1W	5%	1KΩ
R604	ERJ6GEYJ750	S.M.CARB	0.1W	5%	75Ω
R605	ERJ6GEYJ750	S.M.CARB	0.1W	5%	75Ω
R606	ERJ6GEYJ750	S.M.CARB	0.1W	5%	75Ω
R609	ERJ6GEYJ153	S.M.CARB	0.1W	5%	15KΩ
R610	ERJ6GEYJ823	S.M.CARB	0.1W		82KΩ
R612	ERJ6GEYJ392	S.M.CARB	0.1W	5%	3K9Ω
R613	ERJ6GEYJ392	S.M.CARB	0.1W	5%	3K9Ω
R615	ERJ6GEYJ823	S.M.CARB	0.1W		82KΩ
R616	ERJ6GEYJ101	S.M.CARB	0.1W	5%	100Ω
R617	ERJ6GEYJ101	S.M.CARB	0.1W	5%	100Ω
R618	ERJ6GEYJ100	S.M.CARB	0.1W	5%	10Ω
R619	ERJ6GEY0R00	S.M.CARB	0.1W	5%	0Ω
R620	ERJ6GEY0R00	S.M.CARB	0.1W	5%	0Ω
R621	ERJ6GEY0R00	S.M.CARB	0.1W	5%	0Ω
R624	ERJ6GEYJ151	S.M.CARB	0.1W	5%	150Ω
R625	ERJ6GEYJ393	S.M.CARB	0.1W	5%	39KΩ
R626	ERJ6GEYJ153	S.M.CARB	0.1W	5%	15KΩ
R627	ERJ6GEYJ681	S.M.CARB	0.1W	5%	680Ω
R628	ERJ6GEYJ151	S.M.CARB	0.1W	5%	150Ω
R629	ERJ6GEY0R00	S.M.CARB	0.1W	5%	0Ω
R630	ERJ6GEYJ560	S.M.CARB	0.1W	5%	56Ω
R632	ERJ6GEYJ393	S.M.CARB	0.1W	5%	39KΩ
R633	ERJ6GEYJ153	S.M.CARB	0.1W	5%	15KΩ
R634	ERJ6GEYJ681	S.M.CARB	0.1W	5%	680Ω
R635	ERJ6GEYJ151	S.M.CARB	0.1W	5%	150Ω
R636	ERJ6GEY0R00	S.M.CARB	0.1W	5%	0Ω
R637	ERJ6GEYJ331	S.M.CARB	0.1W	5%	330Ω
R639	EVNDXAA03B32	CONTROL	300Ω		
R640	ERJ6GEY0R00	S.M.CARB	0.1W	5%	0Ω
R643	ERJ6GEYJ101	S.M.CARB	0.1W	5%	100Ω
R644	ERJ6GEYJ102	S.M.CARB	0.1W	5%	1KΩ
R645	ERJ6GEYJ271	S.M.CARB	0.1W	5%	270Ω
R646	ERJ6GEY0R00	S.M.CARB	0.1W	5%	0Ω
R647	ERJ6GEYJ151	S.M.CARB	0.1W	5%	150Ω
R648	ERJ6GEYJ150	S.M.CARB	0.1W	5%	15Ω
R649	ERJ6GEY0R00	S.M.CARB	0.1W	5%	0Ω
R651	ERJ6GEYJ225	S.M.CARB	0.125	5%	2.2MΩ
R652	ERJ6GEYJ103	S.M.CARB	0.1W	5%	10KΩ
R653	ERJ6GEYJ103	S.M.CARB	0.1W	5%	10KΩ
R654	ERJ6GEYJ103	S.M.CARB	0.1W	5%	10KΩ
R655	ERJ6GEYJ243	S.M.CARB	0.125W	5%	24KΩ
R656	ERJ6GEYJ103	S.M.CARB	0.1W	5%	10KΩ
R657	ERJ6GEYJ103	S.M.CARB	0.1W	5%	10KΩ
R658	ERJ6GEYJ103	S.M.CARB	0.1W	5%	10KΩ
R659	ERJ6GEYJ102	S.M.CARB	0.1W	5%	1KΩ

Ref No.	Part No.	Description			
R660	ERJ6GEYJ102	S.M.CARB	0.1W	5%	1KΩ
R661	ERJ6GEYJ102	S.M.CARB	0.1W	5%	1KΩ
R662	ERJ6GEY0R00	S.M.CARB	0.1W	5%	0Ω
R663	ERJ6GEY0R00	S.M.CARB	0.1W	5%	0Ω
R664	ERC14GJ206V	SOLID	14W	5%	20MΩ
R665	ERC14GJ206V	SOLID	14W	5%	20MΩ
R711	ERJ6GEYJ224	S.M.CARB	0.1W	5%	220KΩ
R712	ERJ6GEYJ223	S.M.CARB	0.1W	5%	22KΩ
R714	ERJ6GEYJ682	S.M.CARB	0.1W	5%	6K8Ω
R715	ERJ6GEYJ222	S.M.CARB	0.1W	5%	2K2Ω
R716	ERJ6GEY0R00	S.M.CARB	0.1W	5%	0Ω
R717	ERJ6GEYJ153	S.M.CARB	0.1W	5%	15KΩ
R718	ERJ6GEYJ472	S.M.CARB	0.1W	5%	4K7Ω
R753	ERD25TJ333	CARBON	0.25W	5%	33KΩ
R805	232266296706	THERMISTOR			
R806	ERD25TJ101	CARBON	0.25W	5%	100Ω
R807	ERD25TJ104	CARBON	0.25W	5%	100KΩ
R809	ERF10ZK4R7	WOUND	10W	5%	4R7Ω ▲
R810	ERD25TJ223	CARBON	0.25W	5%	22KΩ
R811	ERD25TJ102	CARBON	0.25W	5%	1KΩ
R812	ERD25TJ681	CARBON	0.25W	5%	680Ω
R814	ERD25TJ332	CARBON	0.25W	5%	3K3Ω
R815	ERD25TJ150	CARBON	0.25W	5%	15Ω
R816	ERDS1TJ470	CARBON	0.5W	5%	47Ω
R818	ERD25TJ331	CARBON	0.25W	5%	330Ω
R820	ERG3FJ223	METAL	3W	5%	22KΩ ▲
R821	ERG3FJ223	METAL	3W	5%	22KΩ ▲
R822	ERD25TJ391	CARBON	0.25W	5%	390Ω
R823	ERX2SJR22	RESISTOR	2W	5%	R22Ω
R824	ERX2SJR22	RESISTOR	2W	5%	R22Ω
R825	ERX2SJR22	RESISTOR	2W	5%	R22Ω
R827	ERDS1FJ100	CARBON	0.5W	5%	10Ω ▲
R828	ERD25TJ103	CARBON	0.25W	5%	10KΩ
R829	ERD25TJ471	CARBON	0.25W	5%	470Ω
R831	ERD75TAJ825	CARBON	0.75W	5%	8M2Ω ▲
R832	ERG1SJ331	METAL	1W	5%	330Ω
R835	ERD25TJ220	CARBON	0.25W	5%	22Ω
R836	ERD25TJ100	CARBON	0.25W	5%	10Ω
R837	ERD25TJ153	CARBON	0.25W	5%	15KΩ
R838	ERD25TJ102	CARBON	0.25W	5%	1KΩ
R847	ERQ1CKPR68	METAL	1W	5%	R68Ω ▲
R853	ERO25CKF1002	METAL	0.25W	1%	10KΩ ▲
R854	ERDS1TJ153	CARBON	0.5W	5%	15KΩ
R855	ERD25TJ472	CARBON	0.25W	5%	4K7Ω
R856	ERD25TJ473	CARBON	0.25W	5%	47KΩ
R858	ERO25CKF1002	METAL	0.25W	1%	10KΩ
R862	ERD25TJ472	CARBON	0.25W	5%	4K7Ω
R863	ERG3FJ470	METAL	3W	5%	47Ω ▲
R864	ERDS1TJ103	CARBON	0.5W	5%	10KΩ
R865	ERG3FJ470	METAL	3W	5%	47Ω ▲
R867	ERD25TJ102	CARBON	0.25W	5%	1KΩ
R870	ERD25TJ101	CARBON	0.25W	5%	100Ω
R873	ERDS1TJ2R2	CARBON	0.5W	5%	2.2Ω
R876	ERD25TJ562	CARBON	0.25W	5%	5K6Ω
R877	ERO25CKF1022	METAL	25W	1%	10.2KΩ ▲
R878	ERO25CKF1002	METAL	0.25W	1%	10KΩ ▲
R883	ERD25TJ103	CARBON	0.25W	5%	10KΩ
R885	ERD25TJ103	CARBON	0.25W	5%	10KΩ
R886	ERF10ZK4R7	WOUND	10W	5%	4R7Ω ▲
R888	ERDS1TJ393	CARBON	0.5W	5%	39KΩ
R889	ERD25TJ392	CARBON	0.25W	5%	3K9Ω
R890	ERX3SJR56	RESISTOR	3W	5%	R56Ω
R891	ERD25TJ103	CARBON	0.25W	5%	10KΩ
R892	ERD25TJ222	CARBON	0.25W	5%	2K2Ω
R894	ERD25TJ101	CARBON	0.25W	5%	100Ω
R905	ERJ6GEYJ681	S.M.CARB	0.1W	5%	680Ω
R906	ERJ6GEYJ563	S.M.CARB	0.1W	5%	56KΩ
R907	ERJ6GEYJ822	S.M.CARB	0.1W	5%	8K2Ω
R908	ERJ6GEYJ471	S.M.CARB	0.1W	5%	470Ω
R909	ERJ6GEYJ102	S.M.CARB	0.1W	5%	1KΩ
R909	ERJ6GEYJ222	S.M.CARB	0.1W	5%	2K2Ω
R910	ERJ6GEYJ151	S.M.CARB	0.1W	5%	150Ω
R910	ERJ6GEYJ101	S.M.CARB	0.1W	5%	100Ω
R911	ERD25TJ561	CARBON	0.25W	5%	560Ω
R913	ERJ6GEYJ153	S.M.CARB	0.1W	5%	15KΩ
R913	ERJ6GEYJ183	S.M.CARB	0.1W	5%	18KΩ
R914	ERJ6GEYJ122	S.M.CARB	0.1W	5%	1K2Ω
R914	ERJ6GEYJ222	S.M.CARB	0.1W	5%	2K2Ω
R915	ERJ6GEYJ182	S.M.CARB	0.1W	5%	1K8Ω

Ref No.	Part No.	Description
R915	ERJ6GEYJ242	S.M.CARB 0.1W 5% 2K4Ω
R916	ERJ6GEYJ221	S.M.CARB 0.1W 5% 220Ω
R916	ERJ6GEYJ101	S.M.CARB 0.1W 5% 100Ω
R918	ERJ6GEYJ101	S.M.CARB 0.1W 5% 100Ω
R919	ERQ14AJW390	FUSIBLE 14W 5% 39Ω Δ
R920	ERQ14AJW390	FUSIBLE 14W 5% 39Ω Δ
R922	ERD25TJ683	CARBON 0.25W 5% 68KΩ
R923	ERD25TJ683	CARBON 0.25W 5% 68KΩ
R924	ERDS1FYJ390	CARBON 0.5W 5% 39Ω Δ
R925	ERJ6GEY0R00	S.M.CARB 0.1W 5% 0Ω
R926	ERJ6GEY0R00	S.M.CARB 0.1W 5% 0Ω
R927	ERD25TJ122	CARBON 0.25W 5% 1K2Ω
R928	ERD25TJ2R7	CARBON 0.25W 5% 2R7Ω
R929	ERDS1FYJ471	CARBON 0.5W 5% 470Ω Δ
R930	ERD25TJ2R7	CARBON 0.25W 5% 2R7Ω
R931	ERDS1FYJ390	CARBON 0.5W 5% 39Ω
R932	ERDS1FYJ101	CARBON 0.5W 5% 100Ω
R933	ERJ6GEYJ472	S.M.CARB 0.1W 5% 4K7Ω
R934	ERJ6GEYJ222	S.M.CARB 0.1W 5% 2K2Ω
R935	ERQ14AJW3R9	FUSIBLE 14W 5% 3R9Ω
R936	ERQ1CJP102	METAL 1W 5% 1KΩ
R937	ERQ14AJW100	METAL 0.25W 5% 10Ω
R938	ERD25TJ122	CARBON 0.25W 5% 1K2Ω
R940	ERD25TJ3R3	CARBON 0.25W 5% 3R3Ω
R941	ERD25TJ3R3	CARBON 0.25W 5% 3R3Ω
R1054	ERD25TJ101	CARBON 0.25W 5% 100Ω
R1057	ERD25TJ101	CARBON 0.25W 5% 100Ω
R1058	ERD25TJ471	CARBON 0.25W 5% 470Ω
R1059	ERD25TJ103	CARBON 0.25W 5% 10KΩ
R1061	ERD25TJ103	CARBON 0.25W 5% 10KΩ
R1062	ERD25TJ222	CARBON 0.25W 5% 2K2Ω
R1063	ERD25TJ222	CARBON 0.25W 5% 2K2Ω
R1064	ERD25TJ332	CARBON 0.25W 5% 3K3Ω
R1065	ERD25TJ512	CARBON 0.25W 5% 5K1Ω
R1066	ERD25TJ912	CARBON 0.25W 5% 9K1Ω
R1101	ERJ6GEYJ472	S.M.CARB 0.1W 5% 4K7Ω
R1102	ERJ6GEYJ472	S.M.CARB 0.1W 5% 4K7Ω
R1103	ERJ6GEYJ472	S.M.CARB 0.1W 5% 4K7Ω
R1104	ERJ6GEYJ472	S.M.CARB 0.1W 5% 4K7Ω
R1105	ERJ6GEYJ472	S.M.CARB 0.1W 5% 4K7Ω
R1106	ERJ6GEYJ472	S.M.CARB 0.1W 5% 4K7Ω
R1107	ERJ6GEYJ472	S.M.CARB 0.1W 5% 4K7Ω
R1108	ERJ6GEYJ472	S.M.CARB 0.1W 5% 4K7Ω
R1111	ERJ6GEYJ101	S.M.CARB 0.1W 5% 100Ω
R1112	ERJ6GEYJ101	S.M.CARB 0.1W 5% 100Ω
R1113	ERJ6GEYJ101	S.M.CARB 0.1W 5% 100Ω
R1116	ERJ6GEYJ101	S.M.CARB 0.1W 5% 100Ω
R1117	ERJ6GEYJ101	S.M.CARB 0.1W 5% 100Ω
R1118	ERJ6GEYJ101	S.M.CARB 0.1W 5% 100Ω
R1119	ERJ6GEYJ101	S.M.CARB 0.1W 5% 100Ω
R1120	ERJ6GEYJ101	S.M.CARB 0.1W 5% 100Ω
R1121	ERJ6GEYJ101	S.M.CARB 0.1W 5% 100Ω
R1122	ERJ6GEYJ101	S.M.CARB 0.1W 5% 100Ω
R1123	ERJ6GEYJ472	S.M.CARB 0.1W 5% 4K7Ω
R1124	ERJ6GEYJ103	S.M.CARB 0.1W 5% 10KΩ
R1125	ERJ6GEYJ103	S.M.CARB 0.1W 5% 10KΩ
R1126	ERJ6GEYJ101	S.M.CARB 0.1W 5% 100Ω
R1127	ERJ6GEYJ101	S.M.CARB 0.1W 5% 100Ω
R1128	ERJ6GEYJ100	S.M.CARB 0.1W 5% 10Ω
R1129	ERJ6GEYJ100	S.M.CARB 0.1W 5% 10Ω
R1133	ERJ6GEYJ103	S.M.CARB 0.1W 5% 10KΩ
R1134	ERJ6GEYJ103	S.M.CARB 0.1W 5% 10KΩ
R1135	ERJ6GEY0R00	S.M.CARB 0.1W 5% 0Ω
R1136	ERJ6GEYJ221	S.M.CARB 0.1W 5% 220Ω
R1137	ERJ6GEYJ561	S.M.CARB 0.1W 5% 560Ω
R1138	ERJ6GEYJ103	S.M.CARB 0.1W 5% 10KΩ
R1140	ERJ6GEYJ101	S.M.CARB 0.1W 5% 100Ω
R1142	ERJ6GEYJ103	S.M.CARB 0.1W 5% 10KΩ
R1143	ERJ6GEYJ392	S.M.CARB 0.1W 5% 3K9Ω
R1144	ERJ6GEYJ102	S.M.CARB 0.1W 5% 1KΩ
R1145	ERJ6GEYJ472	S.M.CARB 0.1W 5% 4K7Ω
R1149	ERJ6GEYJ473	S.M.CARB 0.1W 5% 47KΩ
R1150	ERJ6GEYJ472	S.M.CARB 0.1W 5% 4K7Ω
R1151	ERJ6GEYJ472	S.M.CARB 0.1W 5% 4K7Ω
R1152	ERJ6GEYJ472	S.M.CARB 0.1W 5% 4K7Ω
R1153	ERJ6GEYJ472	S.M.CARB 0.1W 5% 4K7Ω
R1154	ERJ6GEYJ472	S.M.CARB 0.1W 5% 4K7Ω
R1156	ERJ6GEYJ182	S.M.CARB 0.1W 5% 1K8Ω
R1163	ERJ6GEYJ152	S.M.CARB 0.1W 5% 1K5Ω

Ref No.	Part No.	Description
R1164	ERJ6GEYJ101	S.M.CARB 0.1W 5% 100Ω
R1169	ERJ6GEYJ102	S.M.CARB 0.1W 5% 1KΩ
R1170	ERJ6GEYJ332	S.M.CARB 0.1W 5% 3K3Ω
R1171	ERJ6GEYJ682	S.M.CARB 0.1W 5% 6K8Ω
R1172	ERJ6GEYJ561	S.M.CARB 0.1W 5% 560Ω
R1174	ERDS1TJ561	CARBON 0.5W 5% 560Ω
R1182	ERJ6GEYJ472	S.M.CARB 0.1W 5% 4K7Ω
R1183	ERJ6GEYJ472	S.M.CARB 0.1W 5% 4K7Ω
R1184	ERJ6GEYJ472	S.M.CARB 0.1W 5% 4K7Ω
R1185	ERJ6GEYJ101	S.M.CARB 0.1W 5% 100Ω
R1186	ERJ6GEYJ103	S.M.CARB 0.1W 5% 10KΩ
R1188	ERJ6GEYJ222	S.M.CARB 0.1W 5% 2K2Ω
R1190	ERJ6GEY0R00	S.M.CARB 0.1W 5% 0Ω
R1191	ERJ6GEYJ104	S.M.CARB 0.1W 5% 100KΩ
R1192	ERJ6GEYJ104	S.M.CARB 0.1W 5% 100KΩ
R1193	ERJ6GEYJ103	S.M.CARB 0.1W 5% 10KΩ
R1194	ERJ6GEYJ101	S.M.CARB 0.1W 5% 100Ω
R1301	ERJ6GEYJ102	S.M.CARB 0.1W 5% 1KΩ
R1302	ERJ6GEYJ392	S.M.CARB 0.1W 5% 3K9Ω
R1305	ERJ6GEYJ560	S.M.CARB 0.1W 5% 56Ω
R1306	ERJ6GEYJ101	S.M.CARB 0.1W 5% 100Ω
R1307	ERJ6GEYJ562	S.M.CARB 0.1W 5% 5K6Ω
R1308	ERJ6GEYJ105	S.M.CARB 0.1W 5% 1MΩ
R1313	ERJ6GEY0R00	S.M.CARB 0.1W 5% 0Ω
R1315	ERJ6GEYJ101	S.M.CARB 0.1W 5% 100Ω
R1317	ERJ6GEYJ181	S.M.CARB 0.1W 5% 180Ω
R1318	ERJ6GEYJ181	S.M.CARB 0.1W 5% 180Ω
R1319	ERJ6GEY0R00	S.M.CARB 0.1W 5% 0Ω
R1320	ERJ6GEYJ472	S.M.CARB 0.1W 5% 4K7Ω
R1321	ERJ6GEYJ472	S.M.CARB 0.1W 5% 4K7Ω
R1322	ERJ6GEYJ103	S.M.CARB 0.1W 5% 10KΩ
R1323	ERJ6GEYJ103	S.M.CARB 0.1W 5% 10KΩ
R1324	ERJ6GEYJ472	S.M.CARB 0.1W 5% 4K7Ω
R1325	ERJ6GEYJ101	S.M.CARB 0.1W 5% 100Ω
R1326	ERJ6GEYJ101	S.M.CARB 0.1W 5% 100Ω
R1327	ERJ6GEYJ470	S.M.CARB 0.1W 5% 47Ω
R1328	ERJ6GEYJ102	S.M.CARB 0.1W 5% 1KΩ
R1329	ERJ6GEY0R00	S.M.CARB 0.1W 5% 0Ω
R1337	ERJ6GEYJ562	S.M.CARB 0.1W 5% 5K6Ω
R1340	ERJ6GEYJ272	S.M.CARB 0.1W 5% 2K7Ω
R1501	ERJ6GEYJ560	S.M.CARB 0.1W 5% 56Ω
R1502	ERJ6GEYJ560	S.M.CARB 0.1W 5% 56Ω
R1504	ERJ6GEYJ121	S.M.CARB 0.1W 5% 120Ω
R1507	ERJ6GEYJ272	S.M.CARB 0.1W 5% 2K7Ω
R1508	ERJ6GEYJ121	S.M.CARB 0.1W 5% 120Ω
R1510	ERJ6GEYJ101	S.M.CARB 0.1W 5% 100Ω
R1511	ERJ6GEYJ272	S.M.CARB 0.1W 5% 2K7Ω
R1513	ERJ6GEYJ272	S.M.CARB 0.1W 5% 2K7Ω
R1515	ERJ6GEYJ102	S.M.CARB 0.1W 5% 1KΩ
R1516	ERJ6GEYJ102	S.M.CARB 0.1W 5% 1KΩ
R1517	ERJ6GEYJ102	S.M.CARB 0.1W 5% 1KΩ
R1518	ERJ6GEYJ101	S.M.CARB 0.1W 5% 100Ω
R1519	ERJ6GEYJ101	S.M.CARB 0.1W 5% 100Ω
R1520	ERJ6GEYJ101	S.M.CARB 0.1W 5% 100Ω
R1523	ERJ6GEYJ101	S.M.CARB 0.1W 5% 100Ω
R1550	ERJ6GEYJ221	S.M.CARB 0.1W 5% 220Ω
R1551	ERJ6GEYJ180	S.M.CARB 0.1W 5% 18Ω
R1552	ERJ6GEYJ560	S.M.CARB 0.1W 5% 56Ω
R1554	ERJ6GEYJ180	S.M.CARB 0.1W 5% 18Ω
R1555	ERJ6GEYJ331	S.M.CARB 0.1W 5% 330Ω
R1560	ERJ6GEYJ101	S.M.CARB 0.1W 5% 100Ω
R1561	ERJ6GEYJ101	S.M.CARB 0.1W 5% 100Ω
R1562	ERJ6GEYJ101	S.M.CARB 0.1W 5% 100Ω
R1563	ERJ6GEYJ180	S.M.CARB 0.1W 5% 18Ω
R1568	ERJ6GEYJ221	S.M.CARB 0.1W 5% 220Ω
R1570	ERJ6GEYJ331	S.M.CARB 0.1W 5% 330Ω
R1572	ERJ6GEYJ561	S.M.CARB 0.1W 5% 560Ω
R1575	ERJ6GEYJ391	S.M.CARB 0.1W 5% 390Ω
R1576	ERJ6GEYJ821	S.M.CARB 0.1W 5% 820Ω
R1577	ERJ6GEYJ750	S.M.CARB 0.1W 5% 75Ω
R1578	ERJ6GEYJ100	S.M.CARB 0.1W 5% 10Ω
R1581	ERJ6GEYJ472	S.M.CARB 0.1W 5% 4K7Ω
R1605	ERJ6GEYJ101	S.M.CARB 0.1W 5% 100Ω
R1606	ERJ6GEYJ101	S.M.CARB 0.1W 5% 100Ω
R1608	ERJ6GEYJ472	S.M.CARB 0.1W 5% 4K7Ω
R1620	ERJ6GEYJ472	S.M.CARB 0.1W 5% 4K7Ω
R1621	ERJ6GEYJ101	S.M.CARB 0.1W 5% 100Ω
R1622	ERJ6GEYJ101	S.M.CARB 0.1W 5% 100Ω
R1624	ERJ6GEY0R00	S.M.CARB 0.1W 5% 0Ω

Ref No.	Part No.	Description
R1625	ERJ6GEYJ271	S.M.CARB 0.1W 5% 270Ω
R1626	ERJ6GEYJ391	S.M.CARB 0.1W 5% 390Ω
R1627	ERJ6GEYJ182	S.M.CARB 0.1W 5% 1K8Ω
R1628	ERJ6GEYJ151	S.M.CARB 0.1W 5% 150Ω
R1629	ERJ6GEYJ201	S.M.CARB 0.1W 5% 200Ω
R1630	ERJ6GEYJ181	S.M.CARB 0.1W 5% 180Ω
R1631	ERJ6GEYJ103	S.M.CARB 0.1W 5% 10KΩ
R1632	ERJ6GEYJ133	S.M.CARB 0.125W 5% 13KΩ
R1633	ERJ6GEYJ151	S.M.CARB 0.1W 5% 150Ω
R1634	ERJ6GEY0R00	S.M.CARB 0.1W 5% 0Ω
R1641	ERJ6GEYJ560	S.M.CARB 0.1W 5% 56Ω
R1643	ERJ6GEYJ102	S.M.CARB 0.1W 5% 1KΩ
R1644	ERJ6GEYJ560	S.M.CARB 0.1W 5% 56Ω
R1646	ERJ6GEYJ331	S.M.CARB 0.1W 5% 330Ω
R1647	ERJ6GEYJ151	S.M.CARB 0.1W 5% 150Ω
R1648	ERJ6GEYJ560	S.M.CARB 0.1W 5% 56Ω
R1649	ERJ6GEYJ560	S.M.CARB 0.1W 5% 56Ω
R1650	ERJ6GEYJ560	S.M.CARB 0.1W 5% 56Ω
R1652	ERJ6GEYJ102	S.M.CARB 0.1W 5% 1KΩ
R1653	ERJ6GEYJ560	S.M.CARB 0.1W 5% 56Ω
R1654	ERJ6GEYJ560	S.M.CARB 0.1W 5% 56Ω
R1656	ERJ6GEYJ102	S.M.CARB 0.1W 5% 1KΩ
R1659	ERJ6GEYJ560	S.M.CARB 0.1W 5% 56Ω
R1662	ERJ6GEYJ560	S.M.CARB 0.1W 5% 56Ω
R1666	ERJ6GEY0R00	S.M.CARB 0.1W 5% 0Ω
R1667	ERJ6GEYJ560	S.M.CARB 0.1W 5% 56Ω
R1668	ERJ6GEYJ560	S.M.CARB 0.1W 5% 56Ω
R1679	ERJ6GEYJ473	S.M.CARB 0.1W 5% 47KΩ
R1680	ERJ6GEYJ153	S.M.CARB 0.1W 5% 15KΩ
R1681	ERJ6GEY0R00	S.M.CARB 0.1W 5% 0Ω
R1682	ERJ6GEYJ151	S.M.CARB 0.1W 5% 150Ω
R1683	ERJ6GEYJ151	S.M.CARB 0.1W 5% 150Ω
R1688	ERJ6GEYJ561	S.M.CARB 0.1W 5% 560Ω
R1701	ERJ6GEYJ180	S.M.CARB 0.1W 5% 18Ω
R1703	ERJ6GEYJ101	S.M.CARB 0.1W 5% 100Ω
R1704	ERJ6GEYJ101	S.M.CARB 0.1W 5% 100Ω
R1705	ERJ6GEYJ473	S.M.CARB 0.1W 5% 47KΩ
R1706	ERJ6GEYJ473	S.M.CARB 0.1W 5% 47KΩ
R1707	ERJ6GEYJ180	S.M.CARB 0.1W 5% 18Ω
R1710	ERJ6GEYJ180	S.M.CARB 0.1W 5% 18Ω
R1713	ERJ6GEYJ472	S.M.CARB 0.1W 5% 4K7Ω
R1716	ERJ6GEY0R00	S.M.CARB 0.1W 5% 0Ω
R1724	ERJ6GEYJ561	S.M.CARB 0.1W 5% 560Ω
R1730	ERJ6GEYJ821	S.M.CARB 0.1W 5% 820Ω
R1777	ERJ6GEYJ561	S.M.CARB 0.1W 5% 560Ω
R1778	ERJ6GEYJ821	S.M.CARB 0.1W 5% 820Ω
R1801	ERJ6GEY0R00	S.M.CARB 0.1W 5% 0Ω
R1802	ERJ6GEY0R00	S.M.CARB 0.1W 5% 0Ω
R1803	ERJ6GEY0R00	S.M.CARB 0.1W 5% 0Ω
R1804	ERJ6GEYJ153	S.M.CARB 0.1W 5% 15KΩ
R1805	ERJ6GEYJ561	S.M.CARB 0.1W 5% 560Ω
R1806	ERJ6GEYJ823	S.M.CARB 0.1W 5% 82KΩ
R1807	ERJ6GEYJ100	S.M.CARB 0.1W 5% 10Ω
R1808	ERJ6GEYJ100	S.M.CARB 0.1W 5% 10Ω
R1809	ERJ6GEYJ391	S.M.CARB 0.1W 5% 390Ω
R1810	ERJ6GEYJ391	S.M.CARB 0.1W 5% 390Ω
R1811	ERJ6GEYJ221	S.M.CARB 0.1W 5% 220Ω
R1814	ERJ6GEY0R00	S.M.CARB 0.1W 5% 0Ω
R1815	ERJ6GEYJ562	S.M.CARB 0.1W 5% 5K6Ω
R1816	ERJ6GEYJ152	S.M.CARB 0.1W 5% 1K5Ω
R1817	ERJ6GEYJ471	S.M.CARB 0.1W 5% 470Ω
R1818	ERJ6GEY0R00	S.M.CARB 0.1W 5% 0Ω
R1819	ERJ6GEY0R00	S.M.CARB 0.1W 5% 0Ω
R1820	ERJ6GEY0R00	S.M.CARB 0.1W 5% 0Ω
R1821	ERQ14AJW221	FUSIBLE 14W 5% 220Ω
R1823	ERJ6GEYJ563	S.M.CARB 0.1W 5% 56KΩ
R1833	ERJ6GEYJ101	S.M.CARB 0.1W 5% 100Ω
R1834	ERJ6GEYJ101	S.M.CARB 0.1W 5% 100Ω
R1835	ERJ6GEYJ472	S.M.CARB 0.1W 5% 4K7Ω
R1839	ERJ6GEYJ225	S.M.CARB 0.125 5% 2.2MΩ
R1841	ERJ6GEYJ682	S.M.CARB 0.1W 5% 6K8Ω
R1842	ERJ6GEYJ121	S.M.CARB 0.1W 5% 120Ω
R1843	ERJ6GEYJ121	S.M.CARB 0.1W 5% 120Ω
R1844	ERJ6GEYJ121	S.M.CARB 0.1W 5% 120Ω
R1860	ERJ6GEYJ101	S.M.CARB 0.1W 5% 100Ω
R1861	ERJ6GEYJ101	S.M.CARB 0.1W 5% 100Ω
R1862	ERJ6GEYJ391	S.M.CARB 0.1W 5% 390Ω
R1863	ERJ6GEYJ391	S.M.CARB 0.1W 5% 390Ω
R1864	ERJ6GEYJ391	S.M.CARB 0.1W 5% 390Ω
R1866	ERJ6GEYJ471	S.M.CARB 0.1W 5% 470Ω

Ref No.	Part No.	Description
R1867	ERJ6GEYJ681	S.M.CARB 0.1W 5% 680Ω
R1868	ERJ6GEY0R00	S.M.CARB 0.1W 5% 0Ω
R1870	ERJ6GEY0R00	S.M.CARB 0.1W 5% 0Ω
R1873	ERJ6GEY0R00	S.M.CARB 0.1W 5% 0Ω
R1874	ERJ6GEY0R00	S.M.CARB 0.1W 5% 0Ω
R1875	ERJ6GEY0R00	S.M.CARB 0.1W 5% 0Ω
R1877	ERC14GJ206D	SOLID 14W 5% 20MΩ
R1878	ERC14GJ206D	SOLID 14W 5% 20MΩ
R1879	ERJ6GEYJ471	S.M.CARB 0.1W 5% 470Ω
R1880	ERJ6GEYJ471	S.M.CARB 0.1W 5% 470Ω
R1881	ERJ6GEYJ471	S.M.CARB 0.1W 5% 470Ω
R1882	ERJ6GEYJ471	S.M.CARB 0.1W 5% 470Ω
R1883	ERJ6GEYJ471	S.M.CARB 0.1W 5% 470Ω
R1884	ERJ6GEYJ471	S.M.CARB 0.1W 5% 470Ω
R1896	ERJ6GEY0R00	S.M.CARB 0.1W 5% 0Ω
R1897	ERJ6GEY0R00	S.M.CARB 0.1W 5% 0Ω
R1898	ERJ6GEY0R00	S.M.CARB 0.1W 5% 0Ω
R1899	ERJ6GEYJ122	S.M.CARB 0.1W 5% 1K2Ω
R1901	ERD25TJ110	CARBON 0.25W 5% 11Ω
R1902	ERD25TJ110	CARBON 0.25W 5% 11Ω
R1903	ERD25TJ154	CARBON 0.25W 5% 150KΩ
R1904	ERD25TJ154	CARBON 0.25W 5% 150KΩ
R1905	ERD25TJ154	CARBON 0.25W 5% 150KΩ
R1906	ERD25TJ753	CARBON 0.25W 5% 75KΩ
R1908	ERD25TJ682	CARBON 0.25W 5% 6K8Ω
R1909	ERD25TJ362	CARBON 0.25W 5% 3.6KΩ
R2001	ERJ6GEYJ473	S.M.CARB 0.1W 5% 47KΩ
R2002	ERD25TJ102	CARBON 0.25W 5% 1KΩ
R2004	ERJ6GEYJ103	S.M.CARB 0.1W 5% 10KΩ
R2005	ERJ6GEYJ101	S.M.CARB 0.1W 5% 100Ω
R2006	ERJ6GEYJ101	S.M.CARB 0.1W 5% 100Ω
R2007	ERJ6GEYJ183	S.M.CARB 0.1W 5% 18KΩ
R2008	ERJ6GEY0R00	S.M.CARB 0.1W 5% 0Ω
R2009	ERJ6GEY0R00	S.M.CARB 0.1W 5% 0Ω
R2010	ERJ6GEYJ101	S.M.CARB 0.1W 5% 100Ω
R2011	ERJ6GEYJ222	S.M.CARB 0.1W 5% 2K2Ω
R2012	ERJ6GEYJ101	S.M.CARB 0.1W 5% 100Ω
R2013	ERJ6GEYJ222	S.M.CARB 0.1W 5% 2K2Ω
R2014	ERJ6GEYJ471	S.M.CARB 0.1W 5% 470Ω
R2015	ERJ6GEYJ222	S.M.CARB 0.1W 5% 2K2Ω
R2016	ERJ6GEYJ471	S.M.CARB 0.1W 5% 470Ω
R2017	ERJ6GEYJ222	S.M.CARB 0.1W 5% 2K2Ω
R2018	ERJ6GEYJ471	S.M.CARB 0.1W 5% 470Ω
R2019	ERJ6GEYJ471	S.M.CARB 0.1W 5% 470Ω
R2020	ERJ6GEYJ562	S.M.CARB 0.1W 5% 5K6Ω
R2021	ERJ6GEYJ102	S.M.CARB 0.1W 5% 1KΩ
R2022	ERJ6GEYJ471	S.M.CARB 0.1W 5% 470Ω
R2023	ERJ6GEY0R00	S.M.CARB 0.1W 5% 0Ω
R2024	ERD25TJ221	CARBON 0.25W 5% 220Ω
R2038	ERJ6GEY0R00	S.M.CARB 0.1W 5% 0Ω
R2040	ERJ6GEYJ223	S.M.CARB 0.1W 5% 22KΩ
R2041	ERJ6GEYJ473	S.M.CARB 0.1W 5% 47KΩ
R2044	ERJ6GEYJ471	S.M.CARB 0.1W 5% 470Ω
R2045	ERJ6GEYJ471	S.M.CARB 0.1W 5% 470Ω
R2351	ERQ14AJW100	METAL 0.25W 5% 10Ω
R2352	ERD25TJ101	CARBON 0.25W 5% 100Ω
R2353	ERD25TJ101	CARBON 0.25W 5% 100Ω
R2354	ERD25TJ473	CARBON 0.25W 5% 47KΩ
R2355	ERD25TJ102	CARBON 0.25W 5% 1KΩ
R2356	ERD25TJ102	CARBON 0.25W 5% 1KΩ
R2357	ERD25TJ102	CARBON 0.25W 5% 1KΩ
R2358	ERD25TJ102	CARBON 0.25W 5% 1KΩ
R2359	ERD25TJ271	CARBON 0.25W 5% 270Ω
R2360	ERD25TJ183	CARBON 0.25W 5% 18KΩ
R2361	ERD25TJ100	CARBON 0.25W 5% 10Ω
R2371	ERQ14AJW100	METAL 0.25W 5% 10Ω
R2372	ERD25TJ101	CARBON 0.25W 5% 100Ω
R2373	ERD25TJ101	CARBON 0.25W 5% 100Ω
R2374	ERD25TJ473	CARBON 0.25W 5% 47KΩ
R2375	ERD25TJ102	CARBON 0.25W 5% 1KΩ
R2376	ERD25TJ102	CARBON 0.25W 5% 1KΩ
R2377	ERD25TJ102	CARBON 0.25W 5% 1KΩ
R2378	ERD25TJ102	CARBON 0.25W 5% 1KΩ
R2379	ERD25TJ271	CARBON 0.25W 5% 270Ω
R2380	ERD25TJ183	CARBON 0.25W 5% 18KΩ
R2381	ERD25TJ100	CARBON 0.25W 5% 10Ω
R2401	ERJ6GEYJ563	S.M.CARB 0.1W 5% 56KΩ
R2402	ERJ6GEYJ563	S.M.CARB 0.1W 5% 56KΩ
R2403	ERJ6GEYJ104	S.M.CARB 0.1W 5% 100KΩ
R2404	ERJ6GEYJ104	S.M.CARB 0.1W 5% 100KΩ

Ref No.	Part No.	Description
R2405	ERJ6GEYJ333	S.M.CARB 0.1W 5% 33KΩ
R2406	ERJ6GEYJ332	S.M.CARB 0.1W 5% 3K3Ω
R2408	ERJ6GEYJ332	S.M.CARB 0.1W 5% 3K3Ω
R2409	ERJ6GEYJ1R0	S.M.CARB0.125W 5% 1R0Ω
R2410	ERJ6GEYJ273	S.M.CARB 0.1W 5% 27KΩ
R2411	ERJ6GEYJ821	S.M.CARB 0.1W 5% 820Ω
R2412	ERJ6GEYJ223	S.M.CARB 0.1W 5% 22KΩ
R2413	ERJ6GEYJ101	S.M.CARB 0.1W 5% 100Ω
R2416	ERJ6GEY0R00	S.M.CARB 0.1W 5% 0Ω
R2417	ERJ6GEY0R00	S.M.CARB 0.1W 5% 0Ω
R2418	ERJ6GEY0R00	S.M.CARB 0.1W 5% 0Ω
R2419	ERJ6GEY0R00	S.M.CARB 0.1W 5% 0Ω
R2420	ERJ6GEY0R00	S.M.CARB 0.1W 5% 0Ω
R2421	ERJ6GEY0R00	S.M.CARB 0.1W 5% 0Ω
R2422	ERJ6GEY0R00	S.M.CARB 0.1W 5% 0Ω
R2423	ERJ6GEYJ104	S.M.CARB 0.1W 5% 100KΩ
R2424	ERJ6GEYJ332	S.M.CARB 0.1W 5% 3K3Ω
R2425	ERJ6GEYJ273	S.M.CARB 0.1W 5% 27KΩ
R2426	ERJ6GEYJ104	S.M.CARB 0.1W 5% 100KΩ
R2427	ERJ6GEYJ102	S.M.CARB 0.1W 5% 1KΩ
R2428	ERJ6GEYJ821	S.M.CARB 0.1W 5% 820Ω
R2430	ERJ6GEYJ153	S.M.CARB 0.1W 5% 15KΩ
R2431	ERJ6GEYJ333	S.M.CARB 0.1W 5% 33KΩ
R2434	ERJ6GEYJ153	S.M.CARB 0.1W 5% 15KΩ
R2435	ERJ6GEYJ153	S.M.CARB 0.1W 5% 15KΩ
R2436	ERJ6GEYJ104	S.M.CARB 0.1W 5% 100KΩ
R2437	ERJ6GEYJ821	S.M.CARB 0.1W 5% 820Ω
R2438	ERJ6GEYJ104	S.M.CARB 0.1W 5% 100KΩ
R2439	ERJ6GEYJ821	S.M.CARB 0.1W 5% 820Ω
R2440	ERJ6GEYJ273	S.M.CARB 0.1W 5% 27KΩ
R2441	ERJ6GEYJ104	S.M.CARB 0.1W 5% 100KΩ
R2442	ERJ6GEYJ102	S.M.CARB 0.1W 5% 1KΩ
R2443	ERJ6GEYJ473	S.M.CARB 0.1W 5% 47KΩ
R2444	ERJ6GEYJ101	S.M.CARB 0.1W 5% 100Ω
R2446	ERJ6GEYJ101	S.M.CARB 0.1W 5% 100Ω
R2447	ERJ6GEYJ472	S.M.CARB 0.1W 5% 4K7Ω
R2448	ERJ6GEYJ104	S.M.CARB 0.1W 5% 100KΩ
R2449	ERJ6GEYJ103	S.M.CARB 0.1W 5% 10KΩ
R2450	ERJ6GEYJ104	S.M.CARB 0.1W 5% 100KΩ
R2451	ERJ6GEYJ104	S.M.CARB 0.1W 5% 100KΩ
R2452	ERJ6GEYJ472	S.M.CARB 0.1W 5% 4K7Ω
R2453	ERJ6GEYJ224	S.M.CARB 0.1W 5% 220KΩ
R2454	ERJ6GEYJ224	S.M.CARB 0.1W 5% 220KΩ
R2455	ERJ6GEYJ104	S.M.CARB 0.1W 5% 100KΩ
R2456	ERJ6GEYJ821	S.M.CARB 0.1W 5% 820Ω
R2457	ERJ6GEYJ273	S.M.CARB 0.1W 5% 27KΩ
R2458	ERJ6GEYJ104	S.M.CARB 0.1W 5% 100KΩ
R2459	ERJ6GEYJ102	S.M.CARB 0.1W 5% 1KΩ
R2461	ERJ6GEYJ101	S.M.CARB 0.1W 5% 100Ω
R2462	ERJ6GEYJ104	S.M.CARB 0.1W 5% 100KΩ
R2463	ERJ6GEYJ104	S.M.CARB 0.1W 5% 100KΩ
R2464	ERJ6GEYJ472	S.M.CARB 0.1W 5% 4K7Ω
R2465	ERJ6GEYJ104	S.M.CARB 0.1W 5% 100KΩ
R2466	ERJ6GEYJ821	S.M.CARB 0.1W 5% 820Ω
R2467	ERJ6GEYJ273	S.M.CARB 0.1W 5% 27KΩ
R2468	ERJ6GEYJ104	S.M.CARB 0.1W 5% 100KΩ
R2469	ERJ6GEYJ102	S.M.CARB 0.1W 5% 1KΩ
R2470	ERJ6GEYJ473	S.M.CARB 0.1W 5% 47KΩ
R2471	ERJ6GEYJ822	S.M.CARB 0.1W 5% 8K2Ω
R2473	ERJ6GEYJ101	S.M.CARB 0.1W 5% 100Ω
R2474	ERJ6GEYJ104	S.M.CARB 0.1W 5% 100KΩ
R2475	ERJ6GEYJ104	S.M.CARB 0.1W 5% 100KΩ
R2476	ERJ6GEYJ102	S.M.CARB 0.1W 5% 1KΩ
R2477	ERJ6GEYJ104	S.M.CARB 0.1W 5% 100KΩ
R2478	ERJ6GEYJ332	S.M.CARB 0.1W 5% 3K3Ω
R2479	ERJ6GEYJ104	S.M.CARB 0.1W 5% 100KΩ
R2480	ERJ6GEYJ104	S.M.CARB 0.1W 5% 100KΩ
R2481	ERJ6GEYJ102	S.M.CARB 0.1W 5% 1KΩ
R2482	ERJ6GEYJ104	S.M.CARB 0.1W 5% 100KΩ
R2483	ERJ6GEYJ332	S.M.CARB 0.1W 5% 3K3Ω
R2484	ERJ6GEYJ273	S.M.CARB 0.1W 5% 27KΩ
R2485	ERJ6GEYJ104	S.M.CARB 0.1W 5% 100KΩ
R2486	ERJ6GEYJ102	S.M.CARB 0.1W 5% 1KΩ
R2487	ERJ6GEYJ103	S.M.CARB 0.1W 5% 10KΩ
R2488	ERJ6GEYJ105	S.M.CARB 0.1W 5% 1MΩ
R2489	ERJ6GEYJ103	S.M.CARB 0.1W 5% 10KΩ
R2490	ERJ6GEYJ472	S.M.CARB 0.1W 5% 4K7Ω
R2491	ERJ6GEYJ153	S.M.CARB 0.1W 5% 15KΩ
R2492	ERJ6GEYJ472	S.M.CARB 0.1W 5% 4K7Ω
R2493	ERJ6GEYJ472	S.M.CARB 0.1W 5% 4K7Ω

Ref No.	Part No.	Description
R2494	ERJ6GEYJ273	S.M.CARB 0.1W 5% 27KΩ
R2495	ERJ6GEYJ102	S.M.CARB 0.1W 5% 1KΩ
R2496	ERJ6GEYJ102	S.M.CARB 0.1W 5% 1KΩ
R2497	ERJ6GEYJ472	S.M.CARB 0.1W 5% 4K7Ω
R2498	ERJ6GEYJ101	S.M.CARB 0.1W 5% 100Ω
R2499	ERJ6GEYJ101	S.M.CARB 0.1W 5% 100Ω
R2502	ERDS1TJ154	CARBON 0.5W 5% 150KΩ
R2503	ERDS1TJ184	CARBON 0.5W 5% 180KΩ
R2504	ERG5FJ473	METAL 5W 5% 47KΩ ▲
R2505	ERG1FJ101P	METAL 1W 5% 100Ω ▲
R2506	ERG1FJ101P	METAL 1W 5% 100Ω ▲
R2507	ERD2FCVJ4R7P	CARBON 2W 5% 4R7Ω
R2508	ERW12PKR33	WOUND 0.5W 10% R33Ω ▲
R2509	ERD2FCVJ4R7P	CARBON 2W 5% 4R7Ω
R2510	TSF19252	FS LINK ▲
R2511	ERJ6GEY0R00	S.M.CARB 0.1W 5% 0Ω
R2512	ERJ6GEY0R00	S.M.CARB 0.1W 5% 0Ω
R2513	TSF19252	FS LINK ▲
R2514	TSF19632	FS LINK ▲
R2515	ERG3FJ470	METAL 3W 5% 47Ω ▲
R2516	ERG3FJ470	METAL 3W 5% 47Ω ▲
R2517	ERDS1TJ2R2	CARBON 0.5W 5% 2.2Ω
R2518	ERD25TJ101	CARBON 0.25W 5% 100Ω
R2519	ERD25TJ102	CARBON 0.25W 5% 1KΩ
R2520	ERDS1TJ103	CARBON 0.5W 5% 10KΩ
R2521	ERJ6GEYJ223	S.M.CARB 0.1W 5% 22KΩ
R2522	ERJ6GEYJ151	S.M.CARB 0.1W 5% 150Ω
R2523	ERG3FJ471	METAL 3W 5% 470Ω ▲
R2524	ERG3FJ471	METAL 3W 5% 470Ω ▲
R2525	ERJ6GEYJ222	S.M.CARB 0.1W 5% 2K2Ω
R2526	ERJ6GEYJ472	S.M.CARB 0.1W 5% 4K7Ω
R2527	ERJ6GEYJ2R2	S.M.CARB0.125W 5% 2R2Ω
R2528	ERJ6GEYJ223	S.M.CARB 0.1W 5% 22KΩ
R2529	ERJ6GEYJ391	S.M.CARB 0.1W 5% 390Ω
R2530	ERJ6GEYJ123	S.M.CARB 0.1W 5% 12KΩ
R2531	ERJ6GEYJ153	S.M.CARB 0.1W 5% 15KΩ
R2532	ERJ6GEYJ2R2	S.M.CARB0.125W 5% 2R2Ω
R2534	ERJ6GEYJ104	S.M.CARB 0.1W 5% 100KΩ
R2535	ERJ6GEYJ101	S.M.CARB 0.1W 5% 100Ω
R2536	ERJ6GEYJ101	S.M.CARB 0.1W 5% 100Ω
R2537	ERJ6GEYJ104	S.M.CARB 0.1W 5% 100KΩ
R2538	ERJ6GEYJ104	S.M.CARB 0.1W 5% 100KΩ
R2539	ERJ6GEYJ102	S.M.CARB 0.1W 5% 1KΩ
R2540	ERJ6GEYJ102	S.M.CARB 0.1W 5% 1KΩ
R2541	ERJ6GEYJ102	S.M.CARB 0.1W 5% 1KΩ
R2542	ERJ6GEYJ102	S.M.CARB 0.1W 5% 1KΩ
R2543	ERJ6GEYJ102	S.M.CARB 0.1W 5% 1KΩ
R2544	ERJ6GEYJ102	S.M.CARB 0.1W 5% 1KΩ
R2545	ERJ6GEYJ393	S.M.CARB 0.1W 5% 39KΩ
R2546	ERJ6GEYJ183	S.M.CARB 0.1W 5% 18KΩ
R2547	ERJ6GEYJ222	S.M.CARB 0.1W 5% 2K2Ω
R2548	ERJ6GEYJ221	S.M.CARB 0.1W 5% 220Ω
R2549	ERJ6GEYJ473	S.M.CARB 0.1W 5% 47KΩ
R2550	ERJ6GEYJ105	S.M.CARB 0.1W 5% 1MΩ
R2564	ERJ6GEYJ333	S.M.CARB 0.1W 5% 33KΩ
R2565	ERJ6GEYJ153	S.M.CARB 0.1W 5% 15KΩ
R2566	ERJ6GEYJ224	S.M.CARB 0.1W 5% 220KΩ
R2569	ERJ6GEYJ333	S.M.CARB 0.1W 5% 33KΩ
R2570	ERJ6GEYJ104	S.M.CARB 0.1W 5% 100KΩ
R2571	ERJ6GEYJ104	S.M.CARB 0.1W 5% 100KΩ
R2572	ERJ6GEYJ472	S.M.CARB 0.1W 5% 4K7Ω
R2573	ERJ6GEYJ124	S.M.CARB 0.1W 5% 120KΩ
R2574	ERJ6GEYJ124	S.M.CARB 0.1W 5% 120KΩ
R2575	ERJ6GEYJ101	S.M.CARB 0.1W 5% 100Ω
R2576	ERJ6GEYJ101	S.M.CARB 0.1W 5% 100Ω
R2577	ERJ6GEYJ183	S.M.CARB 0.1W 5% 18KΩ
R2578	ERJ6GEYJ104	S.M.CARB 0.1W 5% 100KΩ
R2579	ERJ6GEYJ104	S.M.CARB 0.1W 5% 100KΩ
R2580	ERJ6GEYJ104	S.M.CARB 0.1W 5% 100KΩ
R2581	ERJ6GEYJ104	S.M.CARB 0.1W 5% 100KΩ
R2582	ERJ6GEYJ104	S.M.CARB 0.1W 5% 100KΩ
R2583	ERJ6GEYJ102	S.M.CARB 0.1W 5% 1KΩ
R2584	ERJ6GEYJ104	S.M.CARB 0.1W 5% 100KΩ
R2585	ERJ6GEYJ102	S.M.CARB 0.1W 5% 1KΩ
R2586	ERJ6GEYJ561	S.M.CARB 0.1W 5% 560Ω
R2587	ERJ6GEYJ102	S.M.CARB 0.1W 5% 1KΩ
R2588	ERJ6GEYJ222	S.M.CARB 0.1W 5% 2K2Ω
R2589	ERJ6GEYJ392	S.M.CARB 0.1W 5% 3K9Ω
R2590	ERJ6GEYJ822	S.M.CARB 0.1W 5% 8K2Ω

Ref No.	Part No.	Description
R2591	ERJ6GEYJ153	S.M.CARB 0.1W 5% 15KΩ
R2592	ERJ6GEYJ333	S.M.CARB 0.1W 5% 33KΩ
R2593	ERJ6GEYJ683	S.M.CARB 0.1W 5% 68KΩ
R2594	ERJ6GEYJ124	S.M.CARB 0.1W 5% 120KΩ
R2596	ERJ6GEYJ102	S.M.CARB 0.1W 5% 1KΩ
R2597	ERJ6GEYJ102	S.M.CARB 0.1W 5% 1KΩ
R2598	ERJ6GEYJ102	S.M.CARB 0.1W 5% 1KΩ
R2703	ERJ6GEYJ473	S.M.CARB 0.1W 5% 47KΩ
R2704	ERJ6GEYJ102	S.M.CARB 0.1W 5% 1KΩ
R2705	ERJ6GEY0R00	S.M.CARB 0.1W 5% 0Ω
R2706	ERJ6GEY0R00	S.M.CARB 0.1W 5% 0Ω
R2707	ERJ6GEYJ391	S.M.CARB 0.1W 5% 390Ω
R2708	ERJ6GEYJ103	S.M.CARB 0.1W 5% 10KΩ
R2709	ERJ6GEYJ103	S.M.CARB 0.1W 5% 10KΩ
R2710	ERJ6GEYJ103	S.M.CARB 0.1W 5% 10KΩ
R2711	ERJ6GEYJ103	S.M.CARB 0.1W 5% 10KΩ
R2712	ERJ6GEYJ622	S.M.CARB0.125W 5% 6.2KΩ
R2713	ERJ6GEYJ622	S.M.CARB0.125W 5% 6.2KΩ
R2714	ERJ6GEYJ103	S.M.CARB 0.1W 5% 10KΩ
R2715	ERJ6GEYJ103	S.M.CARB 0.1W 5% 10KΩ
R2716	ERJ6GEYJ103	S.M.CARB 0.1W 5% 10KΩ
R2717	ERJ6GEYJ622	S.M.CARB0.125W 5% 6.2KΩ
R2718	ERJ6GEYJ103	S.M.CARB 0.1W 5% 10KΩ
R2801	ERJ6GEYJ473	S.M.CARB 0.1W 5% 47KΩ
R2802	ERJ6GEYJ103	S.M.CARB 0.1W 5% 10KΩ
R2803	ERJ6GEYJ103	S.M.CARB 0.1W 5% 10KΩ
R2804	ERJ6GEYJ104	S.M.CARB 0.1W 5% 100KΩ
R2805	ERJ6GEYJ563	S.M.CARB 0.1W 5% 56KΩ
R2806	ERJ6GEYJ474	S.M.CARB 0.1W 5% 470KΩ
R2807	ERJ6GEYJ104	S.M.CARB 0.1W 5% 100KΩ
R2808	ERJ6GEYJ563	S.M.CARB 0.1W 5% 56KΩ
R2809	ERJ6GEYJ474	S.M.CARB 0.1W 5% 470KΩ
R2810	ERJ6GEYJ474	S.M.CARB 0.1W 5% 470KΩ
R2811	ERJ6GEYJ563	S.M.CARB 0.1W 5% 56KΩ
R2812	ERJ6GEYJ104	S.M.CARB 0.1W 5% 100KΩ
R2813	ERJ6GEYJ104	S.M.CARB 0.1W 5% 100KΩ
R2814	ERJ6GEYJ474	S.M.CARB 0.1W 5% 470KΩ
R2815	ERJ6GEYJ563	S.M.CARB 0.1W 5% 56KΩ
R2816	ERJ6GEYJ102	S.M.CARB 0.1W 5% 1KΩ
R2817	ERJ6GEYJ473	S.M.CARB 0.1W 5% 47KΩ
R2818	ERJ6GEYJ102	S.M.CARB 0.1W 5% 1KΩ
R2819	ERJ6GEYJ473	S.M.CARB 0.1W 5% 47KΩ
R2820	ERJ6GEYJ102	S.M.CARB 0.1W 5% 1KΩ
R2821	ERJ6GEYJ473	S.M.CARB 0.1W 5% 47KΩ
R2822	ERJ6GEYJ102	S.M.CARB 0.1W 5% 1KΩ
R2823	ERJ6GEYJ473	S.M.CARB 0.1W 5% 47KΩ
R3006	ERJ6GEYJ750	S.M.CARB 0.1W 5% 75Ω
R3111	ERJ6GEYJ102	S.M.CARB 0.1W 5% 1KΩ
R3112	ERJ6GEYJ102	S.M.CARB 0.1W 5% 1KΩ
R3114	ERJ6GEYJ681	S.M.CARB 0.1W 5% 680Ω
R3115	ERJ6GEYJ104	S.M.CARB 0.1W 5% 100KΩ
R3117	ERJ6GEYJ104	S.M.CARB 0.1W 5% 100KΩ
R3118	ERJ6GEYJ681	S.M.CARB 0.1W 5% 680Ω
R3119	ERJ6GEYJ333	S.M.CARB 0.1W 5% 33KΩ
R3120	ERJ6GEYJ101	S.M.CARB 0.1W 5% 100Ω
R3121	ERJ6GEYJ101	S.M.CARB 0.1W 5% 100Ω
R3122	ERJ6GEYJ333	S.M.CARB 0.1W 5% 33KΩ
R3123	ERJ6GEYJ153	S.M.CARB 0.1W 5% 15KΩ
R3124	ERJ6GEYJ750	S.M.CARB 0.1W 5% 75Ω
R3125	ERJ6GEYJ470	S.M.CARB 0.1W 5% 47Ω
R3126	ERJ6GEYJ102	S.M.CARB 0.1W 5% 1KΩ
R3127	ERJ6GEYJ102	S.M.CARB 0.1W 5% 1KΩ
R3128	ERJ6GEYJ104	S.M.CARB 0.1W 5% 100KΩ
R3129	ERJ6GEYJ104	S.M.CARB 0.1W 5% 100KΩ
R3130	ERJ6GEYJ681	S.M.CARB 0.1W 5% 680Ω
R3131	ERJ6GEYJ681	S.M.CARB 0.1W 5% 680Ω
R3132	ERD2FCVVG100T	CARBON 2W 2% 10Ω
R3133	ERJ6GEYJ101	S.M.CARB 0.1W 5% 100Ω
R3134	ERJ6GEYJ101	S.M.CARB 0.1W 5% 100Ω
R3135	ERJ6GEYJ101	S.M.CARB 0.1W 5% 100Ω
R3136	ERJ6GEYJ101	S.M.CARB 0.1W 5% 100Ω
R3137	ERJ6GEYJ750	S.M.CARB 0.1W 5% 75Ω
R3138	ERJ6GEYJ470	S.M.CARB 0.1W 5% 47Ω
R3139	ERJ6GEYJ101	S.M.CARB 0.1W 5% 100Ω
R3140	ERJ6GEYJ101	S.M.CARB 0.1W 5% 100Ω
R3141	ERJ6GEYJ101	S.M.CARB 0.1W 5% 100Ω
R3142	ERJ6GEYJ101	S.M.CARB 0.1W 5% 100Ω
R3143	ERJ6GEYJ333	S.M.CARB 0.1W 5% 33KΩ
R3144	ERJ6GEYJ101	S.M.CARB 0.1W 5% 100Ω
R3145	ERJ6GEYJ101	S.M.CARB 0.1W 5% 100Ω

Ref No.	Part No.	Description
R3146	ERJ6GEYJ333	S.M.CARB 0.1W 5% 33KΩ
R3147	ERJ6GEYJ153	S.M.CARB 0.1W 5% 15KΩ
R3148	ERJ6GEYJ750	S.M.CARB 0.1W 5% 75Ω
R3149	ERJ6GEYJ750	S.M.CARB 0.1W 5% 75Ω
R3150	ERJ6GEYJ470	S.M.CARB 0.1W 5% 47Ω
R3151	ERJ6GEYJ750	S.M.CARB 0.1W 5% 75Ω
R3152	ERJ6GEYJ101	S.M.CARB 0.1W 5% 100Ω
R3153	ERJ6GEYJ101	S.M.CARB 0.1W 5% 100Ω
R3154	ERD2FCVVG100T	CARBON 2W 2% 10Ω
R3156	ERJ6GEYJ471	S.M.CARB 0.1W 5% 470Ω
R3157	ERJ6GEYJ221	S.M.CARB 0.1W 5% 220Ω
R3158	ERJ6GEYJ470	S.M.CARB 0.1W 5% 47Ω
R3159	ERJ6GEYJ681	S.M.CARB 0.1W 5% 680Ω
R3160	ERJ6GEYJ563	S.M.CARB 0.1W 5% 56KΩ
R3161	ERJ6GEYJ121	S.M.CARB 0.1W 5% 120Ω
R3162	ERJ6GEYJ101	S.M.CARB 0.1W 5% 100Ω
R3163	ERJ6GEYJ153	S.M.CARB 0.1W 5% 15KΩ
R3164	ERJ6GEYJ182	S.M.CARB 0.1W 5% 1K8Ω
R3165	ERJ6GEYJ103	S.M.CARB 0.1W 5% 10KΩ
R3166	ERJ6GEYJ822	S.M.CARB 0.1W 5% 8K2Ω
R3167	ERJ6GEYJ103	S.M.CARB 0.1W 5% 10KΩ
R3168	ERD2FCVVG100T	CARBON 2W 2% 10Ω
R3169	ERJ6GEY0R00	S.M.CARB 0.1W 5% 0Ω
R3170	ERJ6GEYJ222	S.M.CARB 0.1W 5% 2K2Ω
R3171	ERJ6GEYJ123	S.M.CARB 0.1W 5% 12KΩ
R3172	ERJ6GEYJ152	S.M.CARB 0.1W 5% 1K5Ω
R3173	ERJ6GEYJ561	S.M.CARB 0.1W 5% 560Ω
R3174	ERJ6GEYJ152	S.M.CARB 0.1W 5% 1K5Ω
R3175	ERJ6GEYJ562	S.M.CARB 0.1W 5% 5K6Ω
R3178	ERJ6GEY0R00	S.M.CARB 0.1W 5% 0Ω
R3180	ERJ6GEY0R00	S.M.CARB 0.1W 5% 0Ω
R3182	ERJ6GEY0R00	S.M.CARB 0.1W 5% 0Ω
R3184	ERJ6GEY0R00	S.M.CARB 0.1W 5% 0Ω
R3185	ERJ6GEYJ333	S.M.CARB 0.1W 5% 33KΩ
R3186	ERJ6GEYJ101	S.M.CARB 0.1W 5% 100Ω
R3187	ERJ6GEYJ333	S.M.CARB 0.1W 5% 33KΩ
R3188	ERJ6GEYJ101	S.M.CARB 0.1W 5% 100Ω
R3192	ERJ6GEY0R00	S.M.CARB 0.1W 5% 0Ω
R3193	ERJ6GEY0R00	S.M.CARB 0.1W 5% 0Ω
R3194	ERJ6GEYJ750	S.M.CARB 0.1W 5% 75Ω
R3195	ERJ6GEYJ750	S.M.CARB 0.1W 5% 75Ω
R3196	ERJ6GEYJ470	S.M.CARB 0.1W 5% 47Ω
R3197	ERD2FCVVG100T	CARBON 2W 2% 10Ω
R3198	ERJ6GEYJ470	S.M.CARB 0.1W 5% 47Ω
R3199	ERJ6GEYJ470	S.M.CARB 0.1W 5% 47Ω
R3200	ERJ6GEYJ104	S.M.CARB 0.1W 5% 100KΩ
R3201	ERJ6GEYJ332	S.M.CARB 0.1W 5% 3K3Ω
R3202	ERJ6GEYJ332	S.M.CARB 0.1W 5% 3K3Ω
R3205	ERJ6GEYJ104	S.M.CARB 0.1W 5% 100KΩ
R3206	ERJ6GEYJ104	S.M.CARB 0.1W 5% 100KΩ
R3207	ERJ6GEYJ104	S.M.CARB 0.1W 5% 100KΩ
R3208	ERJ6GEYJ101	S.M.CARB 0.1W 5% 100Ω
R3209	ERJ6GEYJ101	S.M.CARB 0.1W 5% 100Ω
R3210	ERJ6GEYJ152	S.M.CARB 0.1W 5% 1K5Ω
R3211	ERJ6GEYJ152	S.M.CARB 0.1W 5% 1K5Ω
R3212	ERJ6GEYJ123	S.M.CARB 0.1W 5% 12KΩ
R3213	ERJ6GEYJ101	S.M.CARB 0.1W 5% 100Ω
R3214	ERJ6GEYJ153	S.M.CARB 0.1W 5% 15KΩ
R3215	ERD2FCVVG100T	CARBON 2W 2% 10Ω
R3216	ERJ6GEYJ680	S.M.CARB 0.1W 5% 68Ω
R3217	ERJ6GEYJ102	S.M.CARB 0.1W 5% 1KΩ
R3218	ERJ6GEYJ750	S.M.CARB 0.1W 5% 75Ω
R3219	ERJ6GEYJ123	S.M.CARB 0.1W 5% 12KΩ
R3220	ERJ6GEYJ101	S.M.CARB 0.1W 5% 100Ω
R3221	ERJ6GEYJ153	S.M.CARB 0.1W 5% 15KΩ
R3222	ERJ6GEYJ680	S.M.CARB 0.1W 5% 68Ω
R3223	ERJ6GEYJ102	S.M.CARB 0.1W 5% 1KΩ
R3224	ERJ6GEYJ750	S.M.CARB 0.1W 5% 75Ω
R3225	ERD2FCVVG100T	CARBON 2W 2% 10Ω
R3226	ERJ6GEYJ153	S.M.CARB 0.1W 5% 15KΩ
R3227	ERJ6GEY0R00	S.M.CARB 0.1W 5% 0Ω
R3228	ERJ6GEYJ680	S.M.CARB 0.1W 5% 68Ω
R3229	ERJ6GEYJ101	S.M.CARB 0.1W 5% 100Ω
R3230	ERJ6GEYJ102	S.M.CARB 0.1W 5% 1KΩ
R3231	ERD2FCVVG100T	CARBON 2W 2% 10Ω
R3232	ERJ6GEYJ272	S.M.CARB 0.1W 5% 2K7Ω
R3233	ERJ6GEYJ331	S.M.CARB 0.1W 5% 330Ω
R3236	ERJ6GEYJ103	S.M.CARB 0.1W 5% 10KΩ
R3237	ERJ6GEYJ103	S.M.CARB 0.1W 5% 10KΩ
R3238	ERJ6GEYJ153	S.M.CARB 0.1W 5% 15KΩ

Ref No.	Part No.	Description
R3239	ERJ6GEYJ153	S.M.CARB 0.1W 5% 15KΩ
R3240	ERJ6GEYJ104	S.M.CARB 0.1W 5% 100KΩ
R3351	ERJ6GEYJ101	S.M.CARB 0.1W 5% 100Ω
R3352	ERJ6GEYJ472	S.M.CARB 0.1W 5% 4K7Ω
R3353	ERJ6GEYJ474	S.M.CARB 0.1W 5% 470KΩ
R3354	ERJ6GEYJ102	S.M.CARB 0.1W 5% 1KΩ
R3355	ERJ6GEYJ391	S.M.CARB 0.1W 5% 390Ω
R3501	ERJ6GEYJ100	S.M.CARB 0.1W 5% 10Ω
R3502	ERJ6GEY0R00	S.M.CARB 0.1W 5% 0Ω
R3503	ERJ6GEYJ471	S.M.CARB 0.1W 5% 470Ω
R3505	ERJ6GEYJ100	S.M.CARB 0.1W 5% 10Ω
R3506	ERJ6GEYJ100	S.M.CARB 0.1W 5% 10Ω
R3507	ERJ6GEYJ472	S.M.CARB 0.1W 5% 4K7Ω
R3508	ERJ6GEYJ151	S.M.CARB 0.1W 5% 150Ω
R3509	ERJ6GEYJ102	S.M.CARB 0.1W 5% 1KΩ
R3513	ERJ6GEYJ471	S.M.CARB 0.1W 5% 470Ω
R3514	ERJ6GEYJ471	S.M.CARB 0.1W 5% 470Ω
R3515	ERJ6GEYJ471	S.M.CARB 0.1W 5% 470Ω
R3516	ERJ6GEYJ472	S.M.CARB 0.1W 5% 4K7Ω
R3517	ERJ6GEYJ102	S.M.CARB 0.1W 5% 1KΩ
R3518	ERJ6GEY0R00	S.M.CARB 0.1W 5% 0Ω
R3520	ERJ6GEYJ221	S.M.CARB 0.1W 5% 220Ω
R3521	ERJ6GEY0R00	S.M.CARB 0.1W 5% 0Ω
R3522	ERJ6GEY0R00	S.M.CARB 0.1W 5% 0Ω
R3523	ERJ6GEY0R00	S.M.CARB 0.1W 5% 0Ω
R3526	ERD25TC0T	CARBON 0.25W 5% 0Ω
R3531	ERJ6GEYJ221	S.M.CARB 0.1W 5% 220Ω
R3532	ERJ6GEYJ391	S.M.CARB 0.1W 5% 390Ω
R3534	ERD25TJ181	CARBON 0.25W 5% 180Ω
R3536	ERJ6GEY0R00	S.M.CARB 0.1W 5% 0Ω
R3539	ERJ6GEY0R00	S.M.CARB 0.1W 5% 0Ω
R3802	ERG3FJ100	METAL 3W 5% 10Ω Δ
R3803	ERJ6GEYJ221	S.M.CARB 0.1W 5% 220Ω
R3804	ERJ6GEYJ101	S.M.CARB 0.1W 5% 100Ω

Ref No.	Part No.	Description
SWITCHES		
S801	ESB91232A	SWITCH Δ
S1051	EVQ23405R	SWITCH
S1052	EVQ23405R	SWITCH
S1053	EVQ23405R	SWITCH
S1054	EVQ23405R	SWITCH
S1055	EVQ23405R	SWITCH
TRANSFORMERS		
T501	TLHA003	TRANSFORMER
T551	ZTFH65011A	F.B.T. Δ
T801	ETP35KAN615U	TRANSFORMER Δ
T802	ETS49AH137ND	TRANSFORMER
T803	ETQ19K55AY	TRANSFORMER
T2502	ETS35AA3J7AC	TRANSFORMER
FILTERS		
X102	EFCV4155A3	CERAMIC FILTER
X104	J3352K	SAW FILTER
X106	EFCT6R0MW5	FILTER
X601	TSSA024	CRYSTAL
X602	TSSA025	CRYSTAL
X1101	TAF10020	CRYSTAL
X1551	TSSA009	CRYSTAL
X1815	TSSA024	CRYSTAL
X1816	TSSA025	CRYSTAL
X1841	TSSA009	CRYSTAL
X2001	4730007158	CRYSTAL
X2501	TAF10059	CRYSTAL
X2502	TAFCSA4.00MG	CRYSTAL
X3501	TSSA009	CRYSTAL

B

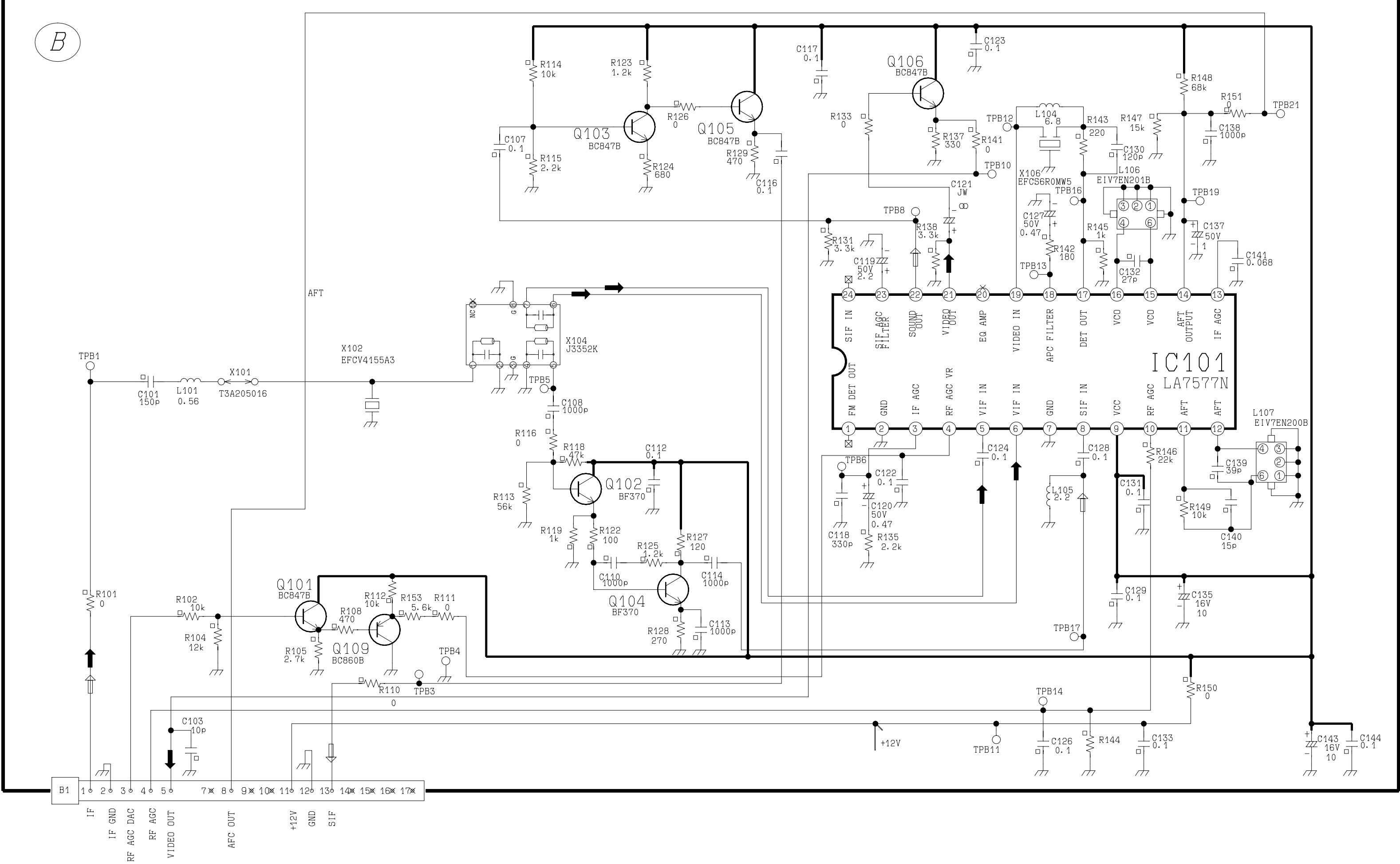

TX-W3202P	TX-W3202P
C555	TAC486T622JC
C574	TAC11142564A
C581	EQ2F4155JZH
C846	NIL
D846	EU02V0
L573	ELHKL8028B
R555	EROS2TKF2802
R557	EROS2TKF492
R558	EROS0PKF4532
R574	ER03FJ151H
R591	ERF2AKR15P
R847	ERQ1CKPR68B
	ERQ1CKPR33S

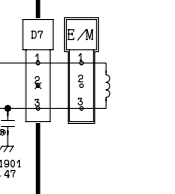
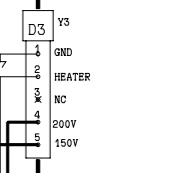
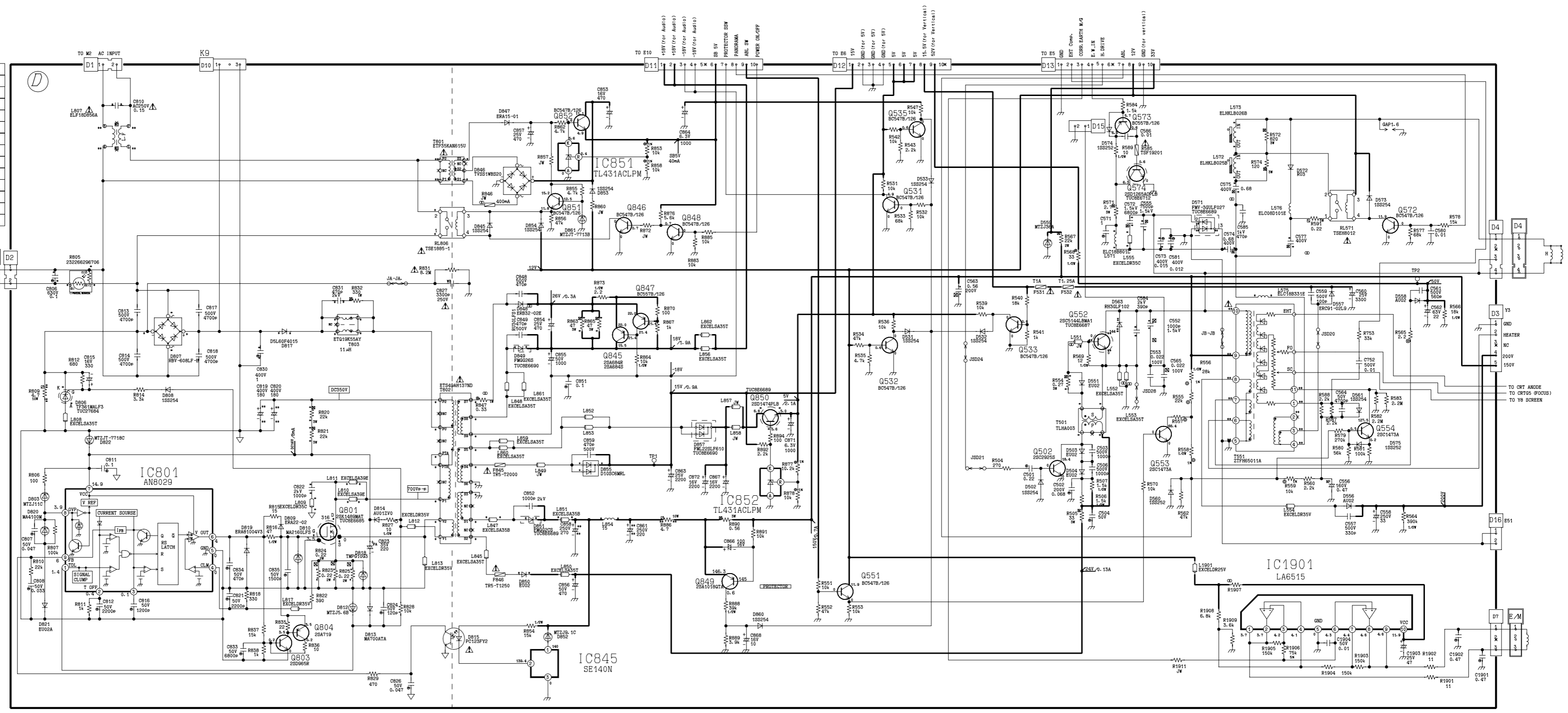

E BOARD
TNP0063

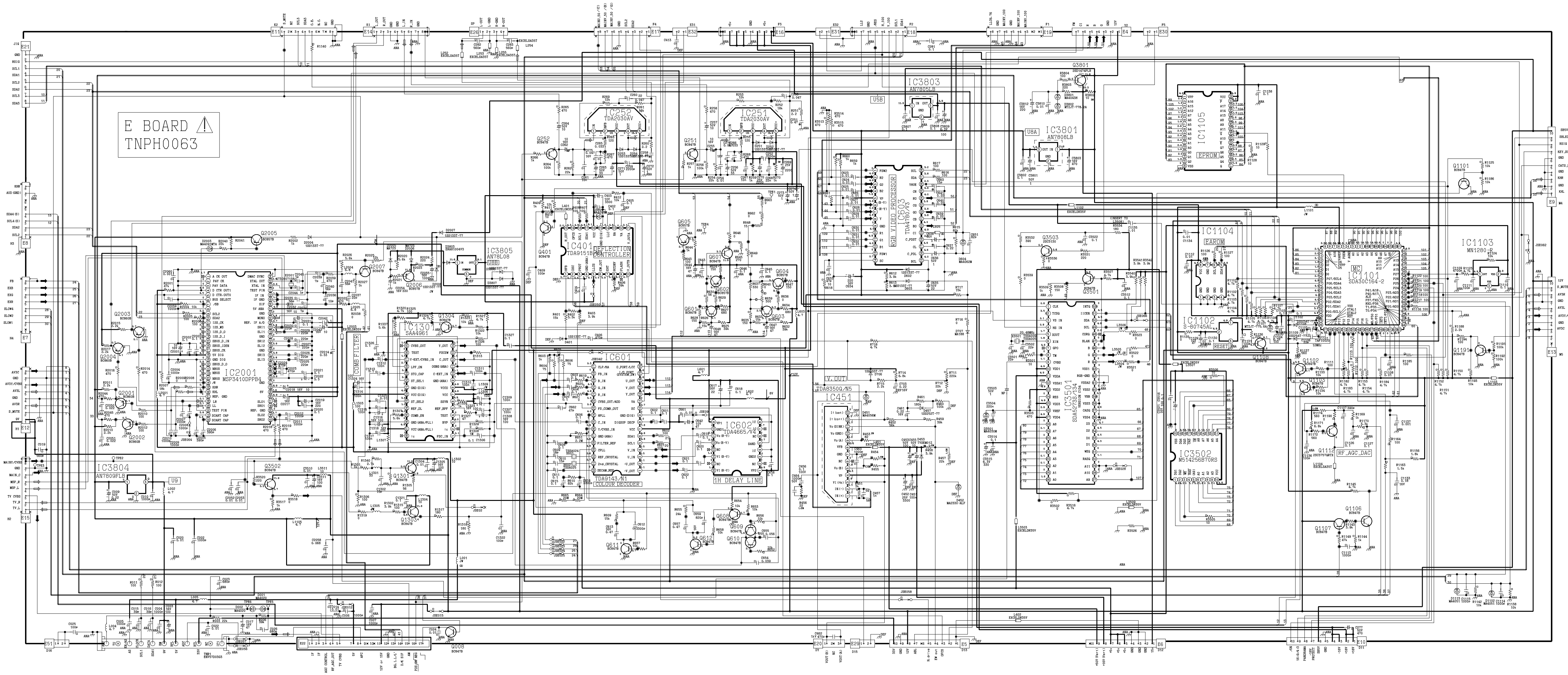

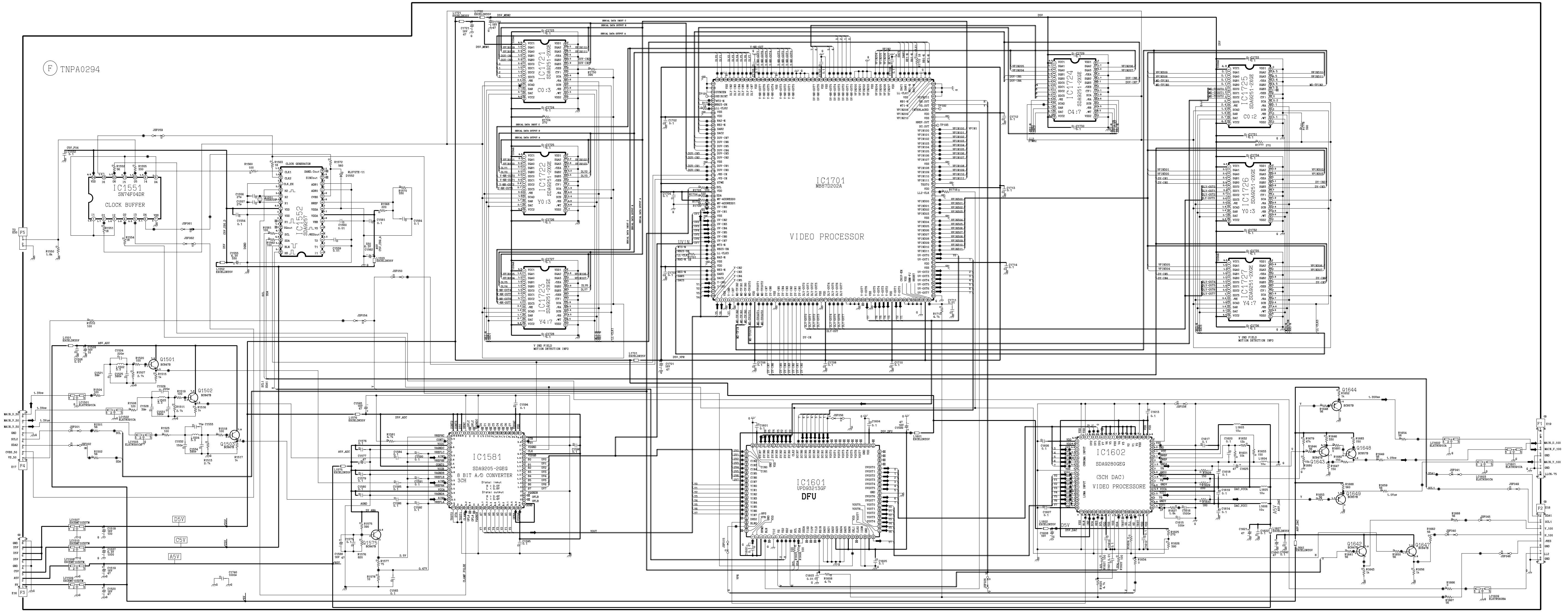

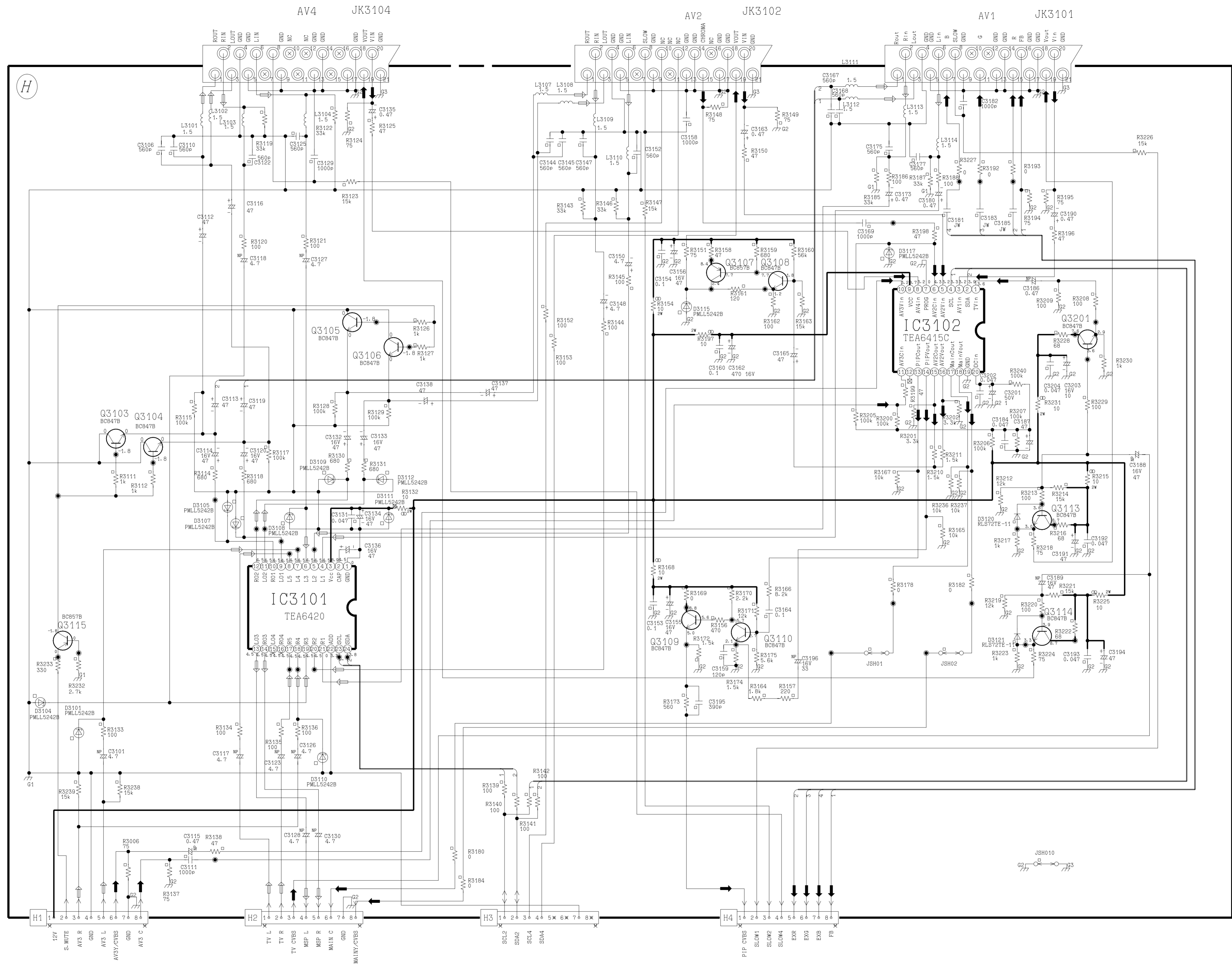

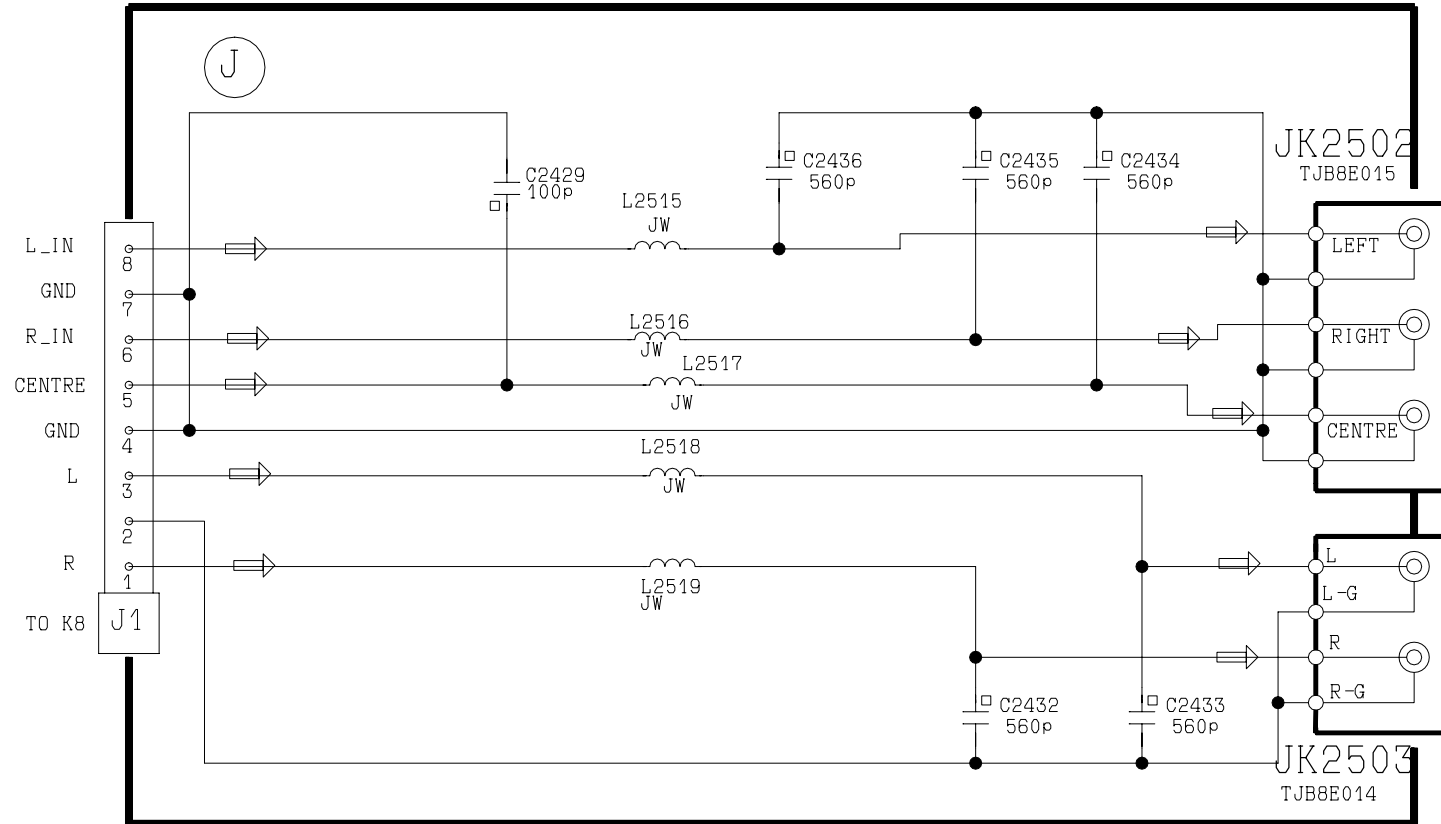

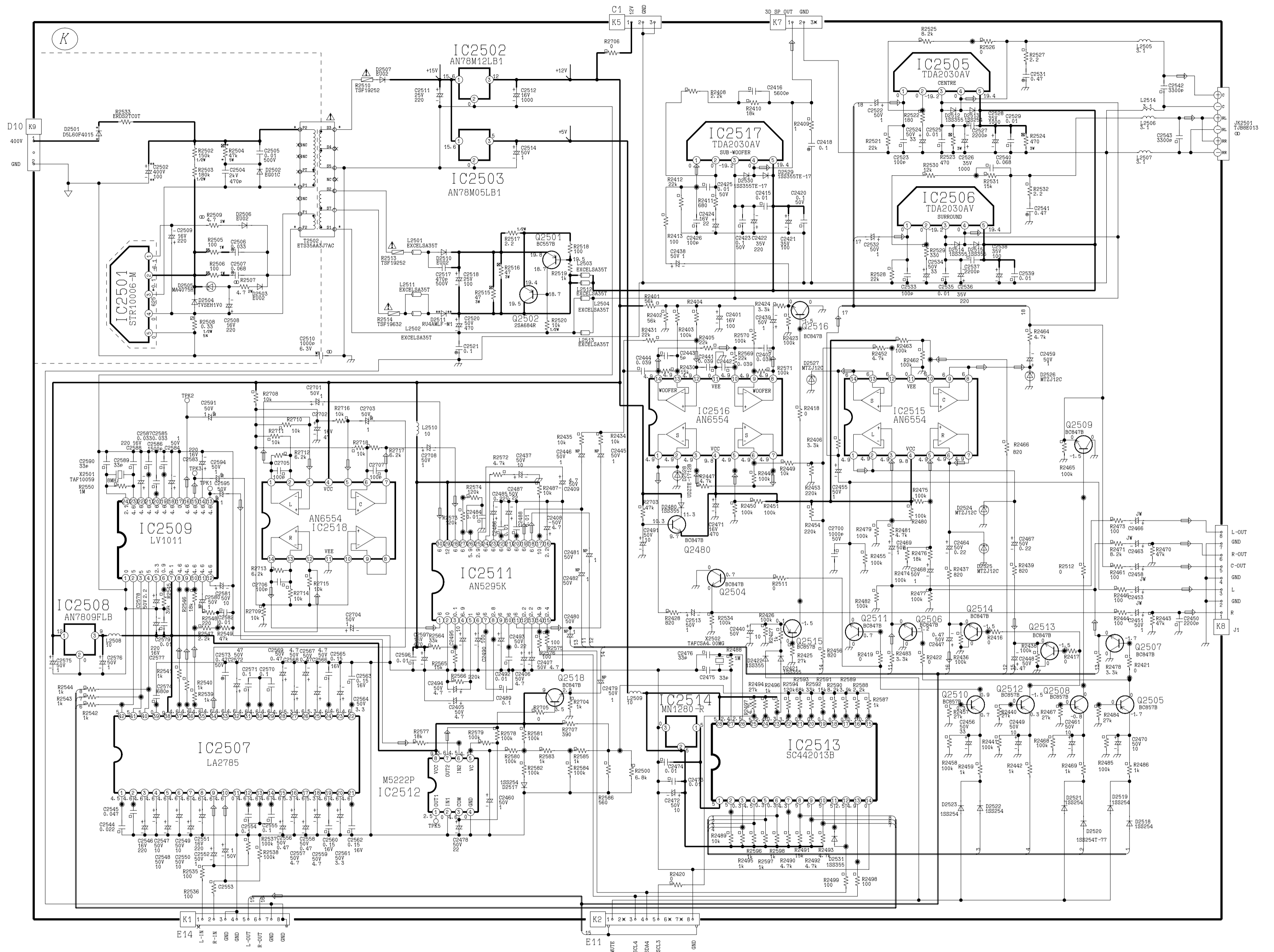

M BOARD
TNPA0291

COLD

HOT

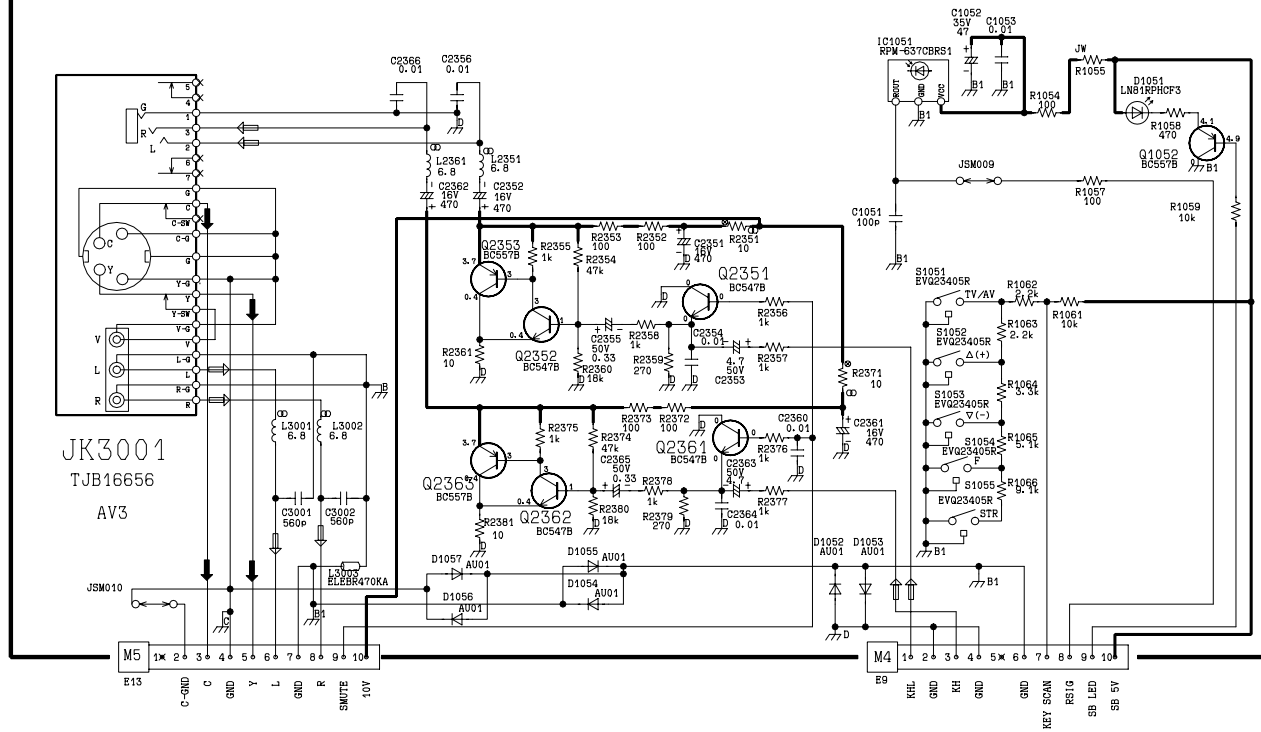
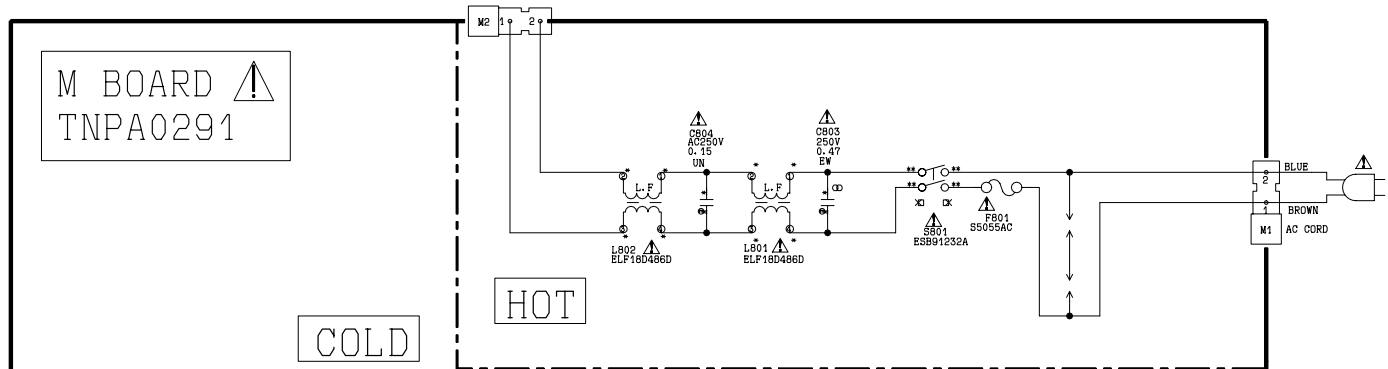

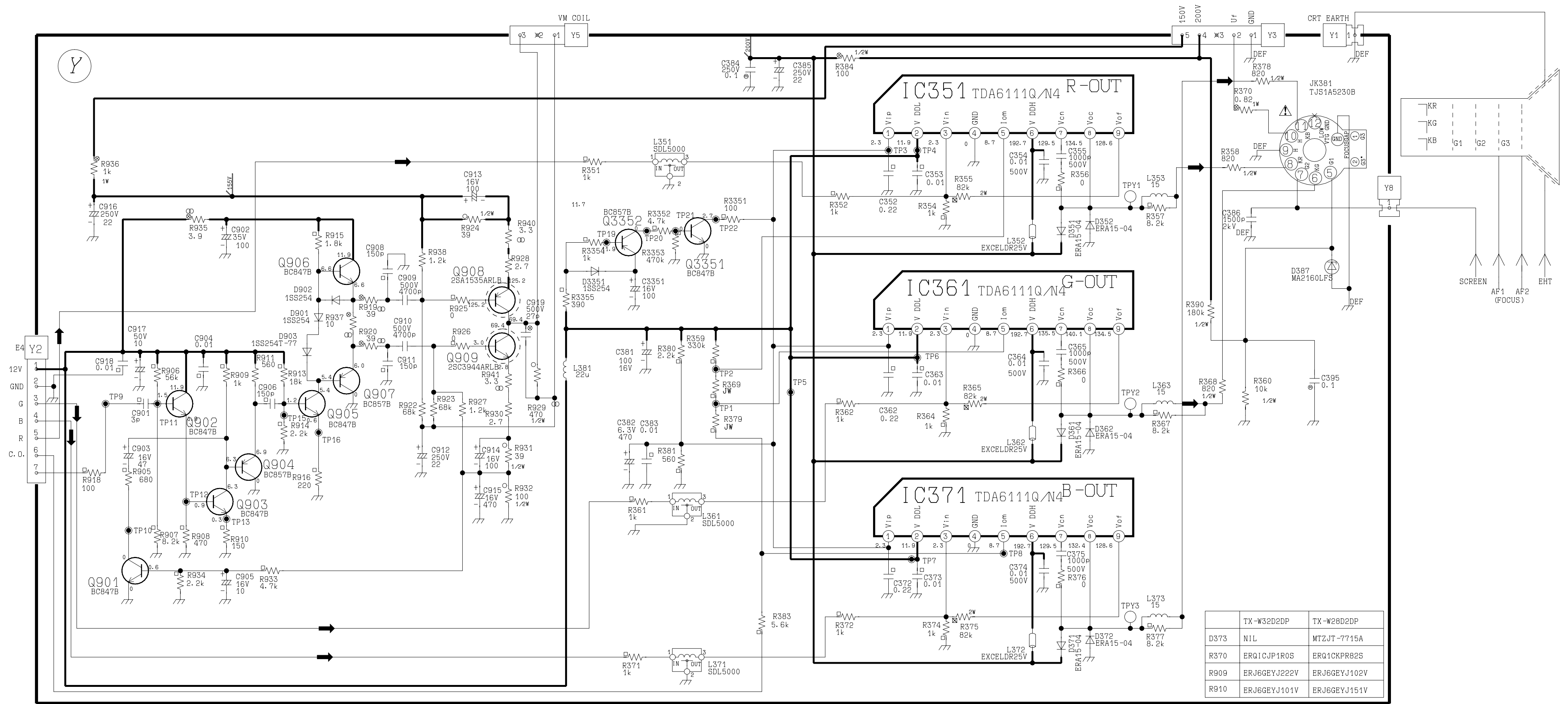

	TX-W32D2DP	TX-W28D2DP
D373	NIL	MTZJT-7715A
R370	ERQ1CJP1R0S	ERQ1CKPR82S
R909	ERJ6GEYJ222V	ERJ6GEYJ102V
R910	ERJ6GEYJ101V	ERJ6GEYJ151V

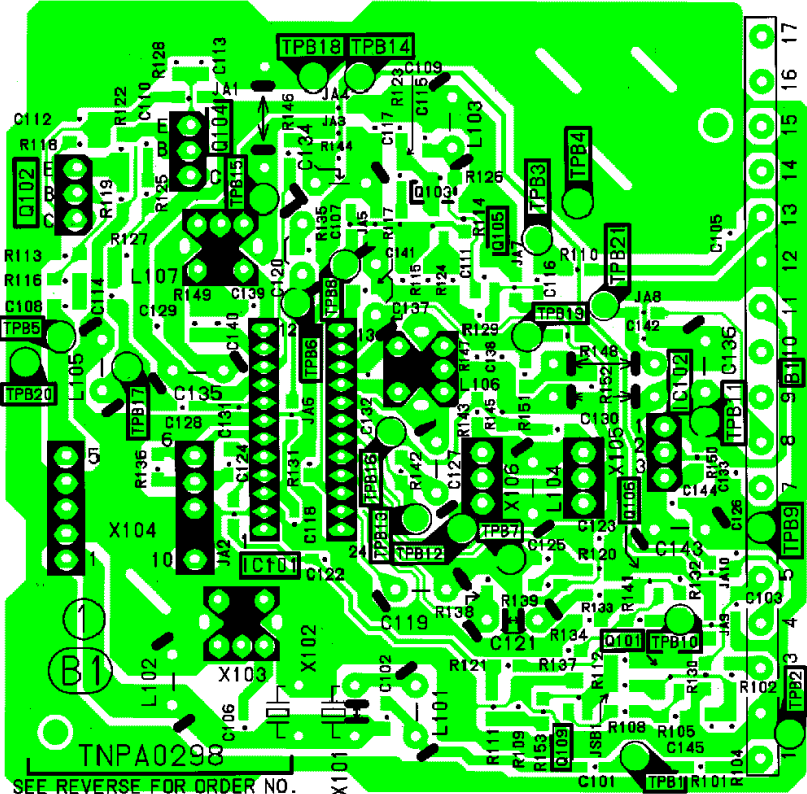

SEE REVERSE FOR ORDER NO.

TNPA0298

1 2 3 4 5 6 7 8 9 10 11 12 13 14 15 16 17

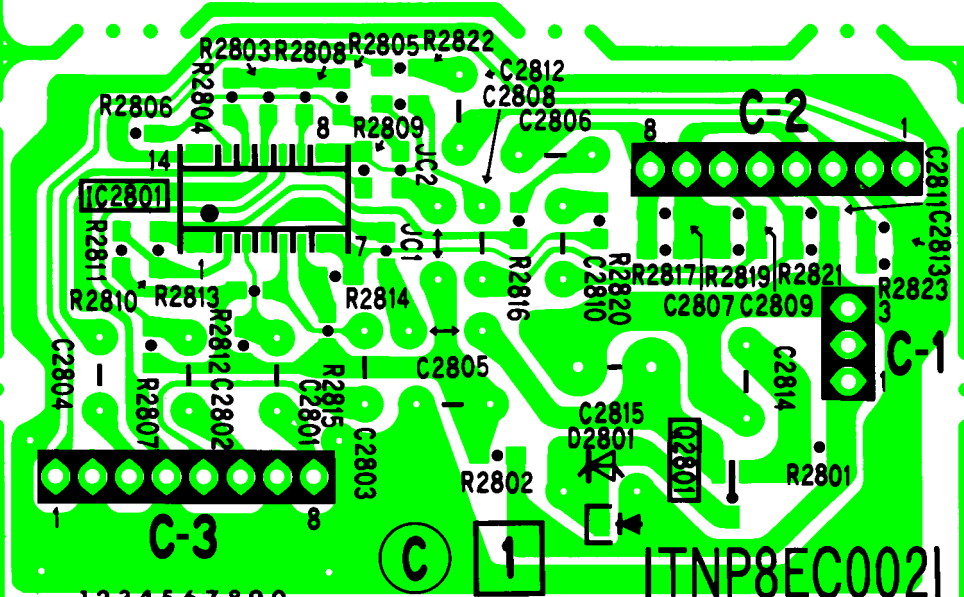

1 2 3 4 5 6 7 8 9 0

TNP8EC002

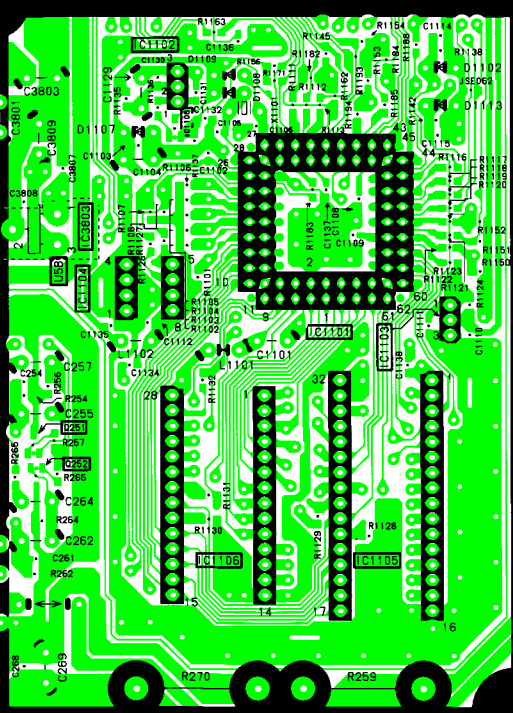
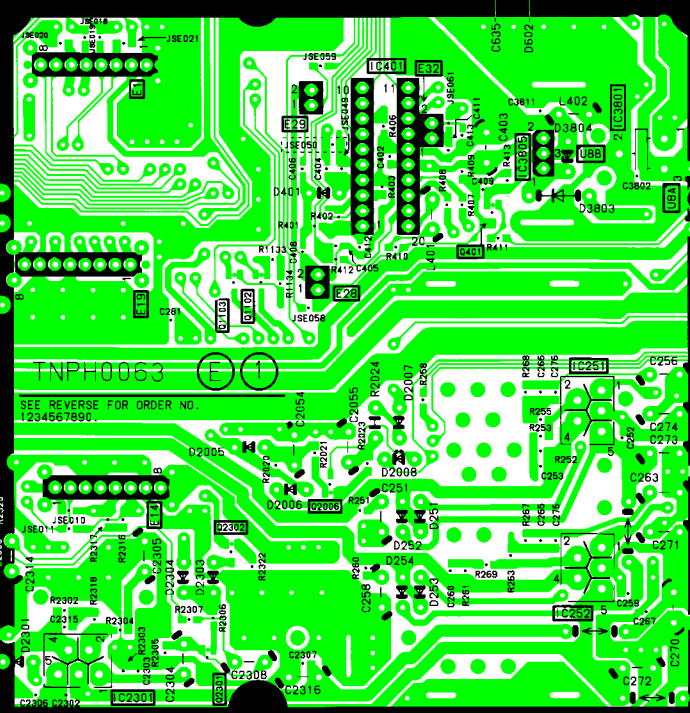
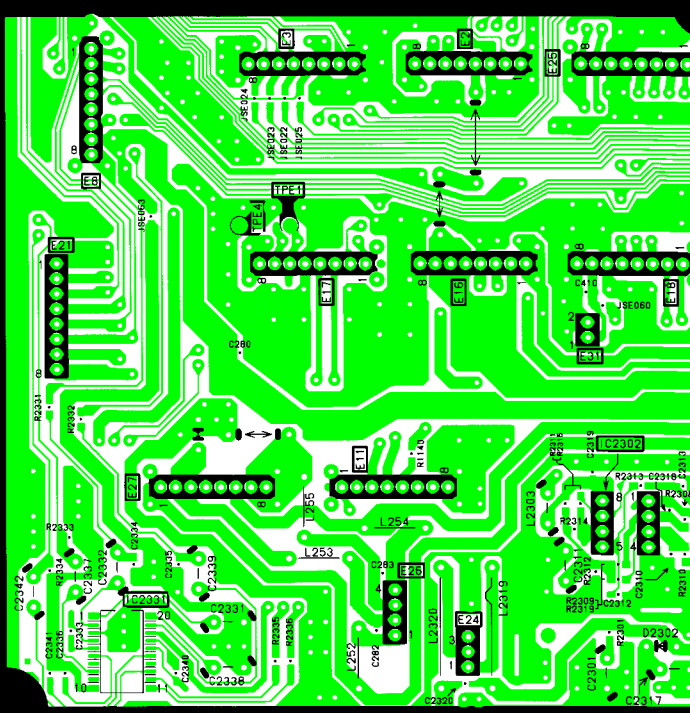
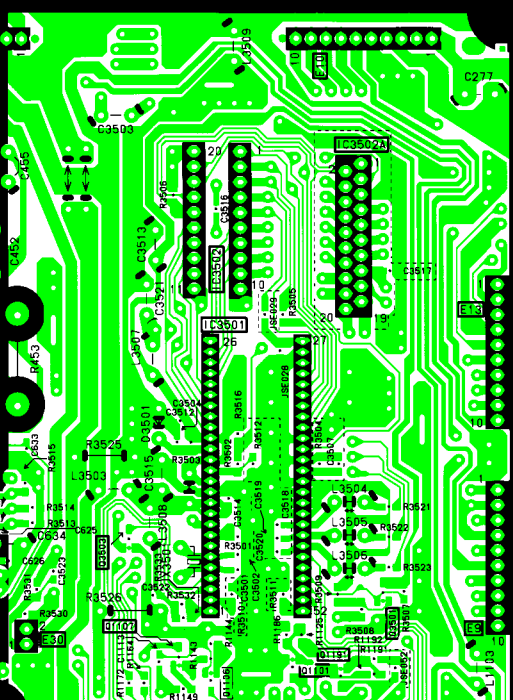
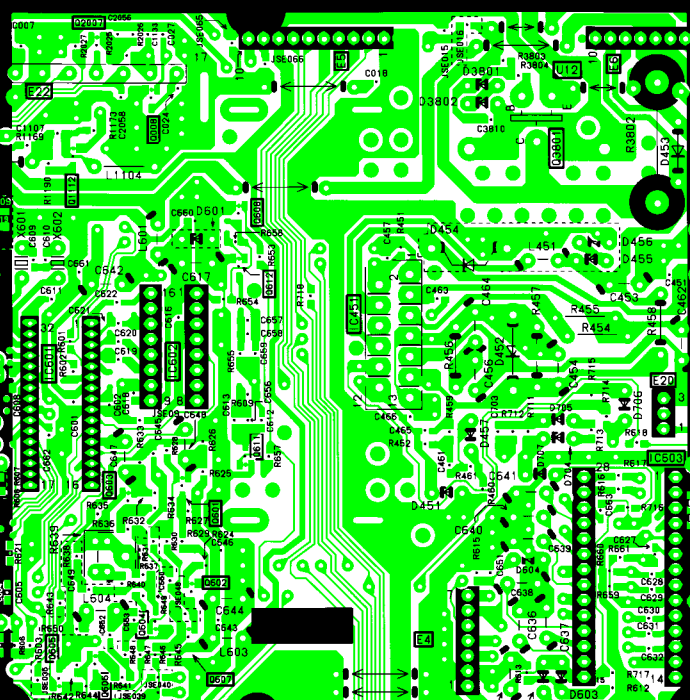
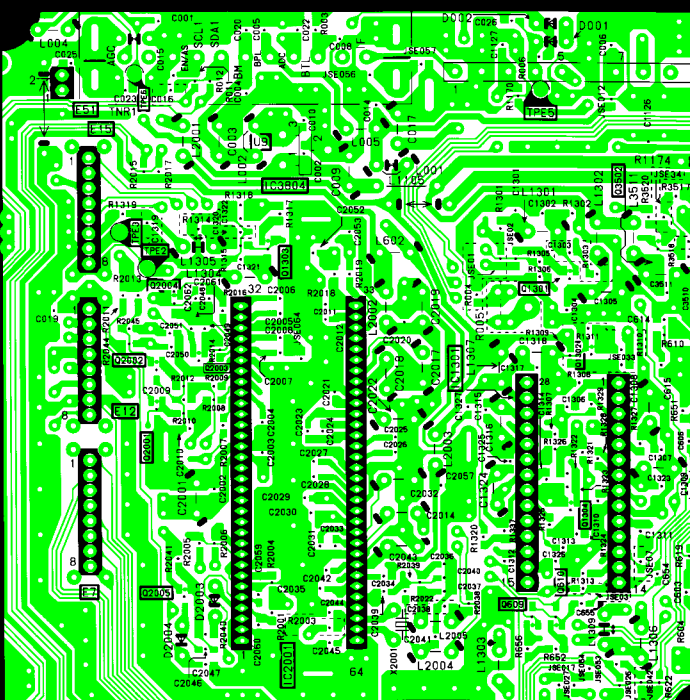

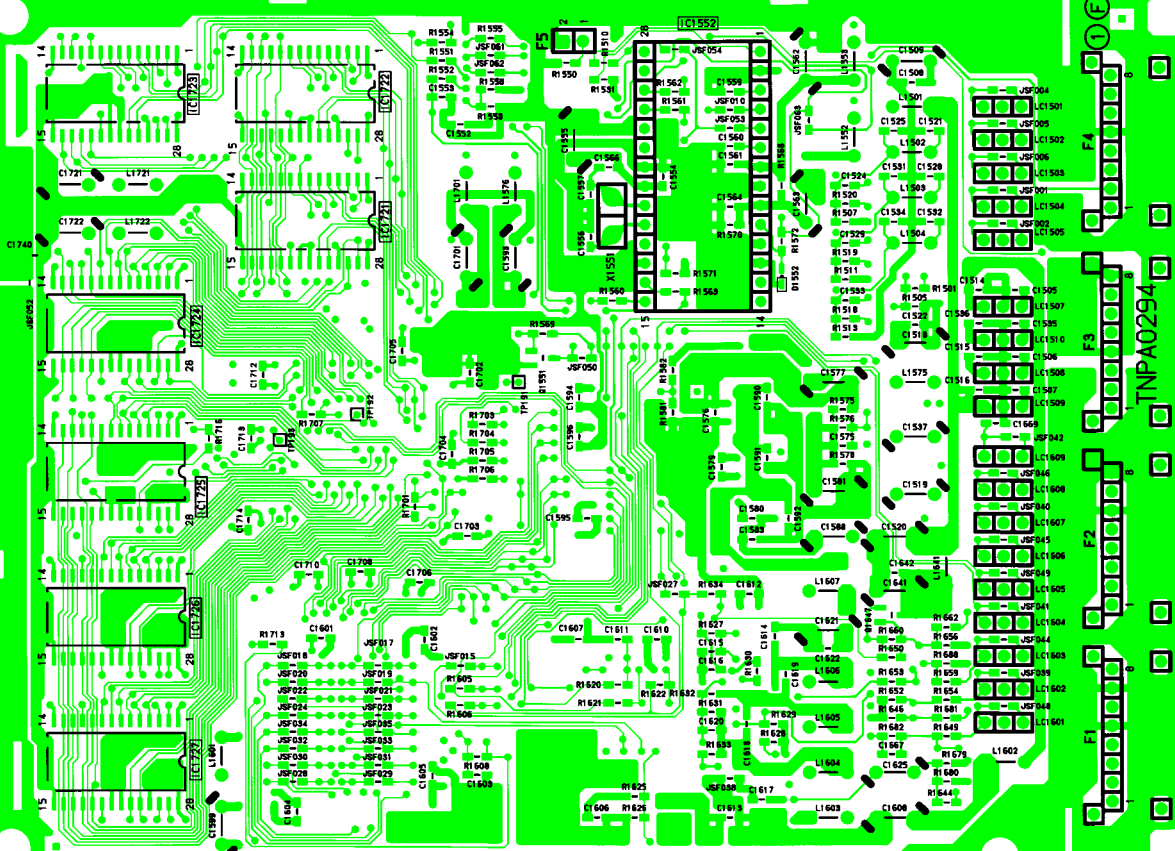

TNPA0294



REF NO. 1...SERIES

G1

JNPA0297

SEE REVERSE FOR ORDER NO.

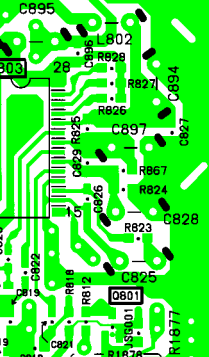
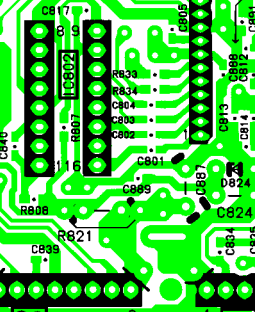
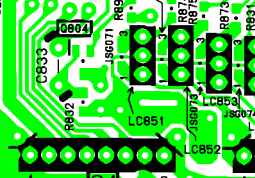
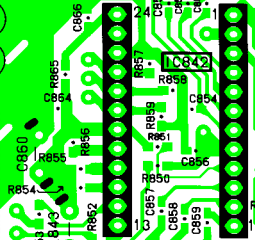
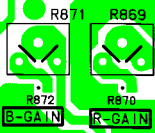
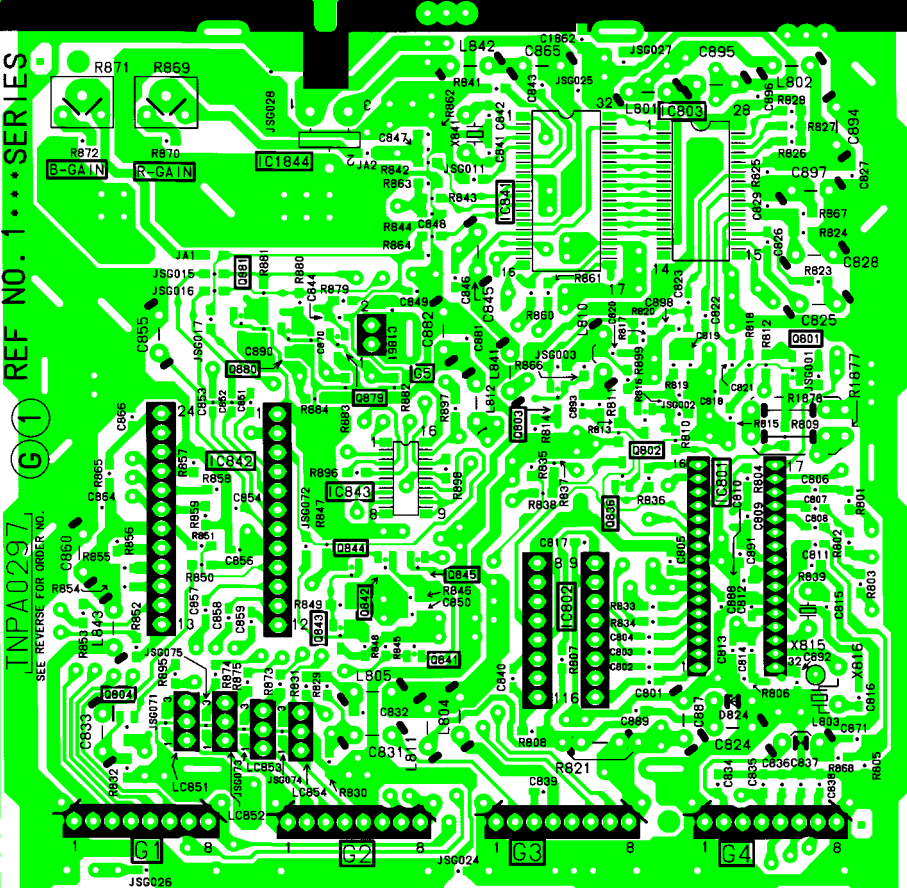

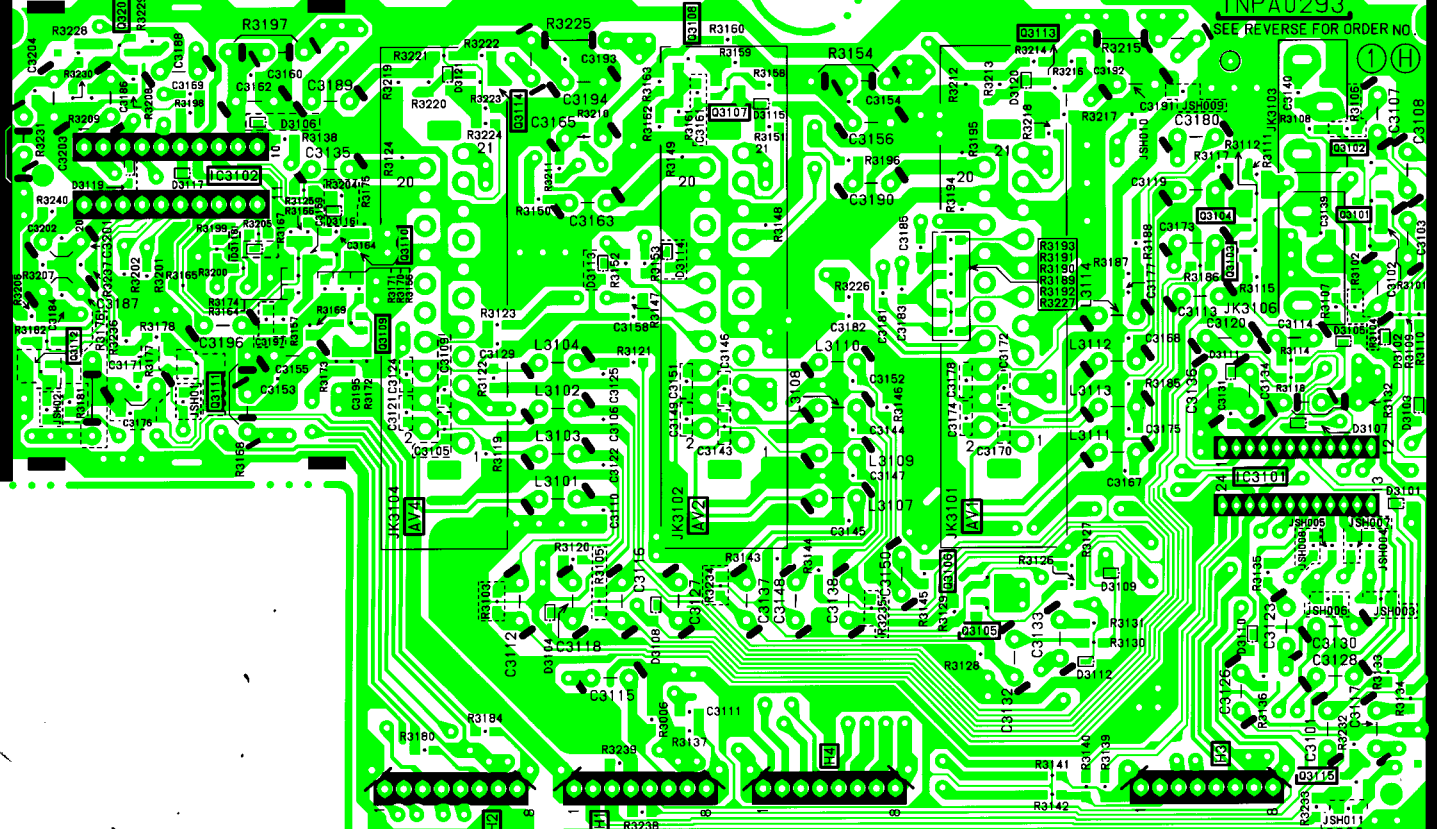

(1) (H)

① ② ③ ④ ⑤ ⑥ ⑦ ⑧ ⑨ ⑩ ⑪ ⑫ ⑬ ⑭ ⑮ ⑯ ⑰ ⑱ ⑲ ⑳ ㉑ ㉒ ㉓ ㉔ ㉕ ㉖ ㉗ ㉘ ㉙ ㉚ ㉛ ㉜ ㉝ ㉞ ㉟ ㊱ ㊲ ㊳ ㊴ ㊵ ㊶ ㊷ ㊸ ㊹ ㊺

① ② ③ ④ ⑤ ⑥ ⑦ ⑧ ⑨ ⑩ ⑪ ⑫ ⑬ ⑭ ⑮ ⑯ ⑰ ⑱ ⑲ ⑳ ㉑ ㉒ ㉓ ㉔ ㉕ ㉖ ㉗ ㉘ ㉙ ㉚ ㉛ ㉜ ㉝ ㉞ ㉟ ㊱ ㊲ ㊳ ㊴ ㊵ ㊶ ㊷ ㊸ ㊹ ㊺

① ② ③ ④ ⑤ ⑥ ⑦ ⑧ ⑨ ⑩ ⑪ ⑫ ⑬ ⑭ ⑮ ⑯ ⑰ ⑱ ⑲ ⑳ ㉑ ㉒ ㉓ ㉔ ㉕ ㉖ ㉗ ㉘ ㉙ ㉚ ㉛ ㉜ ㉝ ㉞ ㉟ ㊱ ㊲ ㊳ ㊴ ㊵ ㊶ ㊷ ㊸ ㊹ ㊺

① ② ③ ④ ⑤ ⑥ ⑦ ⑧ ⑨ ⑩ ⑪ ⑫ ⑬ ⑭ ⑮ ⑯ ⑰ ⑱ ⑲ ⑳ ㉑ ㉒ ㉓ ㉔ ㉕ ㉖ ㉗ ㉘ ㉙ ㉚ ㉛ ㉜ ㉝ ㉞ ㉟ ㊱ ㊲ ㊳ ㊴ ㊵ ㊶ ㊷ ㊸ ㊹ ㊺

① ② ③ ④ ⑤ ⑥ ⑦ ⑧ ⑨ ⑩ ⑪ ⑫ ⑬ ⑭ ⑮ ⑯ ⑰ ⑱ ⑲ ⑳ ㉑ ㉒ ㉓ ㉔ ㉕ ㉖ ㉗ ㉘ ㉙ ㉚ ㉛ ㉜ ㉝ ㉞ ㉟ ㊱ ㊲ ㊳ ㊴ ㊵ ㊶ ㊷ ㊸ ㊹ ㊺

① ② ③ ④ ⑤ ⑥ ⑦ ⑧ ⑨ ⑩ ⑪ ⑫ ⑬ ⑭ ⑮ ⑯ ⑰ ⑱ ⑲ ⑳ ㉑ ㉒ ㉓ ㉔ ㉕ ㉖ ㉗ ㉘ ㉙ ㉚ ㉛ ㉜ ㉝ ㉞ ㉟ ㊱ ㊲ ㊳ ㊴ ㊵ ㊶ ㊷ ㊸ ㊹ ㊺

① ② ③ ④ ⑤ ⑥ ⑦ ⑧ ⑨ ⑩ ⑪ ⑫ ⑬ ⑭ ⑮ ⑯ ⑰ ⑱ ⑲ ⑳ ㉑ ㉒ ㉓ ㉔ ㉕ ㉖ ㉗ ㉘ ㉙ ㉚ ㉛ ㉜ ㉝ ㉞ ㉟ ㊱ ㊲ ㊳ ㊴ ㊵ ㊶ ㊷ ㊸ ㊹ ㊺

① ② ③ ④ ⑤ ⑥ ⑦ ⑧ ⑨ ⑩ ⑪ ⑫ ⑬ ⑭ ⑮ ⑯ ⑰ ⑱ ⑲ ⑳ ㉑ ㉒ ㉓ ㉔ ㉕ ㉖ ㉗ ㉘ ㉙ ㉚ ㉛ ㉜ ㉝ ㉞ ㉟ ㊱ ㊲ ㊳ ㊴ ㊵ ㊶ ㊷ ㊸ ㊹ ㊺

① ② ③ ④ ⑤ ⑥ ⑦ ⑧ ⑨ ⑩ ⑪ ⑫ ⑬ ⑭ ⑮ ⑯ ⑰ ⑱ ⑲ ⑳ ㉑ ㉒ ㉓ ㉔ ㉕ ㉖ ㉗ ㉘ ㉙ ㉚ ㉛ ㉜ ㉝ ㉞ ㉟ ㊱ ㊲ ㊳ ㊴ ㊵ ㊶ ㊷ ㊸ ㊹ ㊺

① ② ③ ④ ⑤ ⑥ ⑦ ⑧ ⑨ ⑩ ⑪ ⑫ ⑬ ⑭ ⑮ ⑯ ⑰ ⑱ ⑲ ⑳ ㉑ ㉒ ㉓ ㉔ ㉕ ㉖ ㉗ ㉘ ㉙ ㉚ ㉛ ㉜ ㉝ ㉞ ㉟ ㊱ ㊲ ㊳ ㊴ ㊵ ㊶ ㊷ ㊸ ㊹ ㊺

① ② ③ ④ ⑤ ⑥ ⑦ ⑧ ⑨ ⑩ ⑪ ⑫ ⑬ ⑭ ⑮ ⑯ ⑰ ⑱ ⑲ ⑳ ㉑ ㉒ ㉓ ㉔ ㉕ ㉖ ㉗ ㉘ ㉙ ㉚ ㉛ ㉜ ㉝ ㉞ ㉟ ㊱ ㊲ ㊳ ㊴ ㊵ ㊶ ㊷ ㊸ ㊹ ㊺

① ② ③ ④ ⑤ ⑥ ⑦ ⑧ ⑨ ⑩ ⑪ ⑫ ⑬ ⑭ ⑮ ⑯ ⑰ ⑱ ⑲ ⑳ ㉑ ㉒ ㉓ ㉔ ㉕ ㉖ ㉗ ㉘ ㉙ ㉚ ㉛ ㉜ ㉝ ㉞ ㉟ ㊱ ㊲ ㊳ ㊴ ㊵ ㊶ ㊷ ㊸ ㊹ ㊺

① ② ③ ④ ⑤ ⑥ ⑦ ⑧ ⑨ ⑩ ⑪ ⑫ ⑬ ⑭ ⑮ ⑯ ⑰ ⑱ ⑲ ⑳ ㉑ ㉒ ㉓ ㉔ ㉕ ㉖ ㉗ ㉘ ㉙ ㉚ ㉛ ㉜ ㉝ ㉞ ㉟ ㊱ ㊲ ㊳ ㊴ ㊵ ㊶ ㊷ ㊸ ㊹ ㊺

① ② ③ ④ ⑤ ⑥ ⑦ ⑧ ⑨ ⑩ ⑪ ⑫ ⑬ ⑭ ⑮ ⑯ ⑰ ⑱ ⑲ ⑳ ㉑ ㉒ ㉓ ㉔ ㉕ ㉖ ㉗ ㉘ ㉙ ㉚ ㉛ ㉜ ㉝ ㉞ ㉟ ㊱ ㊲ ㊳ ㊴ ㊵ ㊶ ㊷ ㊸ ㊹ ㊺

① ② ③ ④ ⑤ ⑥ ⑦ ⑧ ⑨ ⑩ ⑪ ⑫ ⑬ ⑭ ⑮ ⑯ ⑰ ⑱ ⑲ ⑳ ㉑ ㉒ ㉓ ㉔ ㉕ ㉖ ㉗ ㉘ ㉙ ㉚ ㉛ ㉜ ㉝ ㉞ ㉟ ㊱ ㊲ ㊳ ㊴ ㊵ ㊶ ㊷ ㊸ ㊹ ㊺

① ② ③ ④ ⑤ ⑥ ⑦ ⑧ ⑨ ⑩ ⑪ ⑫ ⑬ ⑭ ⑮ ⑯ ⑰ ⑱ ⑲ ⑳ ㉑ ㉒ ㉓ ㉔ ㉕ ㉖ ㉗ ㉘ ㉙ ㉚ ㉛ ㉜ ㉝ ㉞ ㉟ ㊱ ㊲ ㊳ ㊴ ㊵ ㊶ ㊷ ㊸ ㊹ ㊺

① ② ③ ④ ⑤ ⑥ ⑦ ⑧ ⑨ ⑩ ⑪ ⑫ ⑬ ⑭ ⑮ ⑯ ⑰ ⑱ ⑲ ⑳ ㉑ ㉒ ㉓ ㉔ ㉕ ㉖ ㉗ ㉘ ㉙ ㉚ ㉛ ㉜ ㉝ ㉞ ㉟ ㊱ ㊲ ㊳ ㊴ ㊵ ㊶ ㊷ ㊸ ㊹ ㊺

① ② ③ ④ ⑤ ⑥ ⑦ ⑧ ⑨ ⑩ ⑪ ⑫ ⑬ ⑭ ⑮ ⑯ ⑰ ⑱ ⑲ ⑳ ㉑ ㉒ ㉓ ㉔ ㉕ ㉖ ㉗ ㉘ ㉙ ㉚ ㉛ ㉜ ㉝ ㉞ ㉟ ㊱ ㊲ ㊳ ㊴ ㊵ ㊶ ㊷ ㊸ ㊹ ㊺

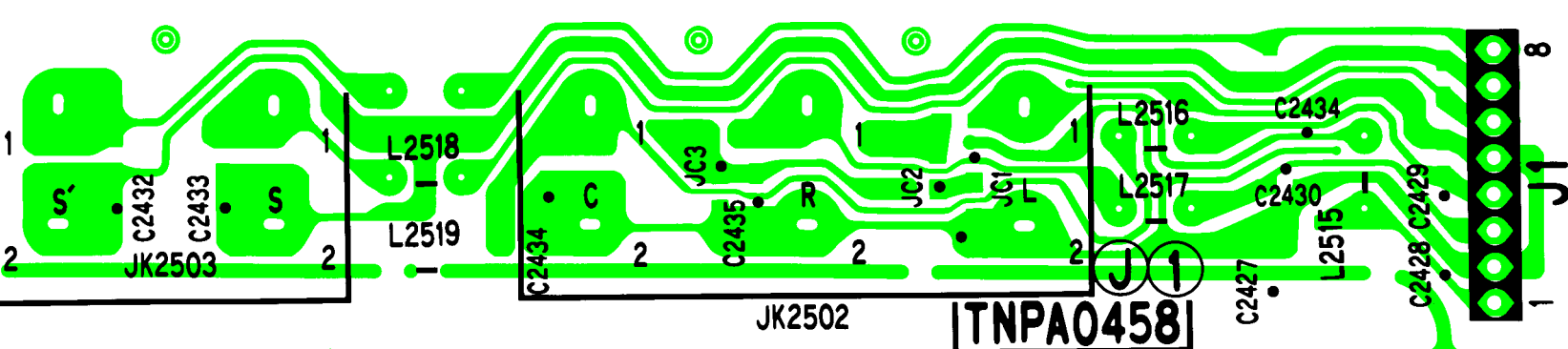

C2432
JK2503
C2433

L2518
L2519

C2434

JC3

C2435

R

JC2

JC1

L2516
L2517

C2427

C2434
C2430

L2515

C2428
C2429

JK2502

TNPA0458

J1

J11

8

1

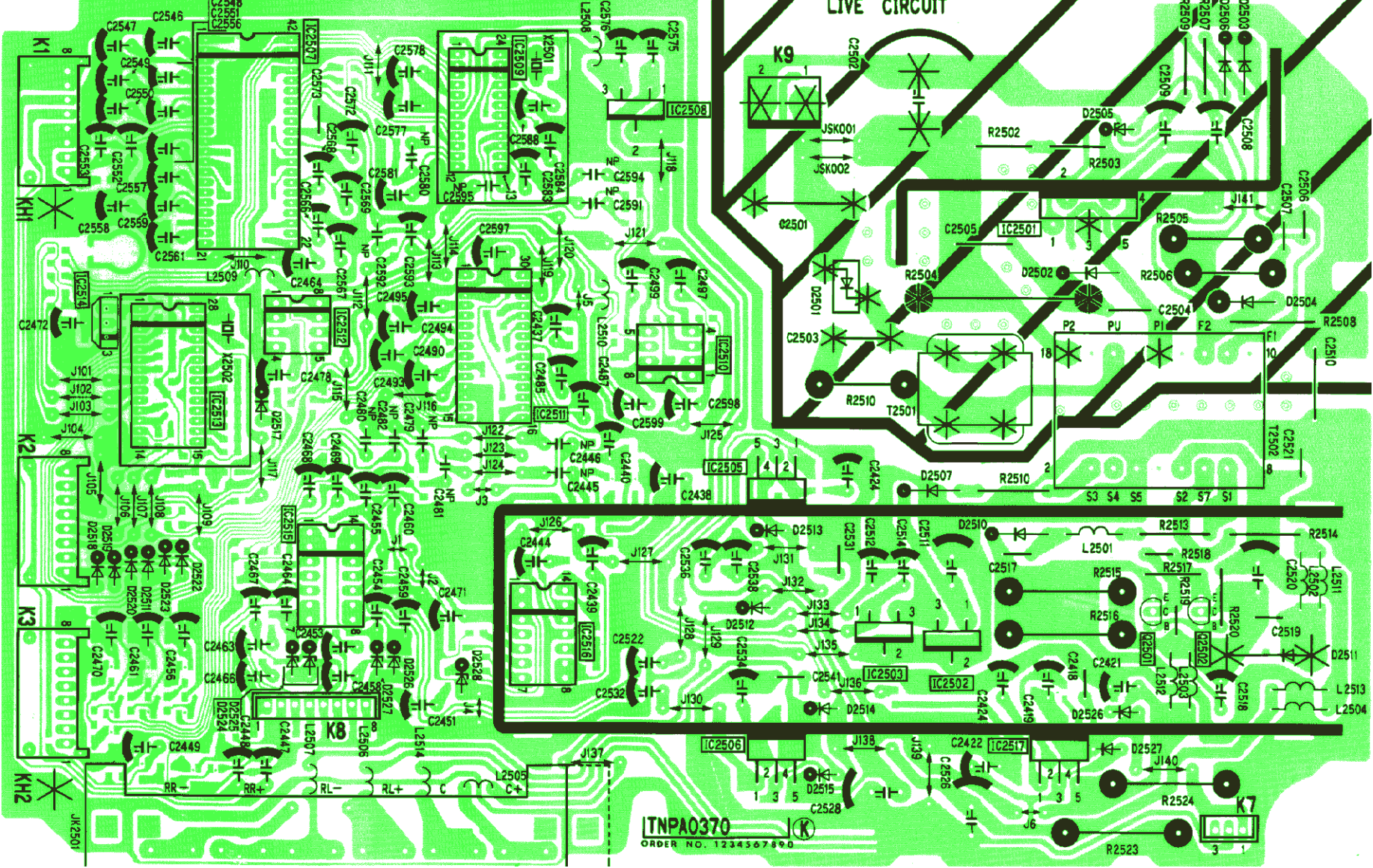

1TNP A0370

ORDER NO. 1234567890



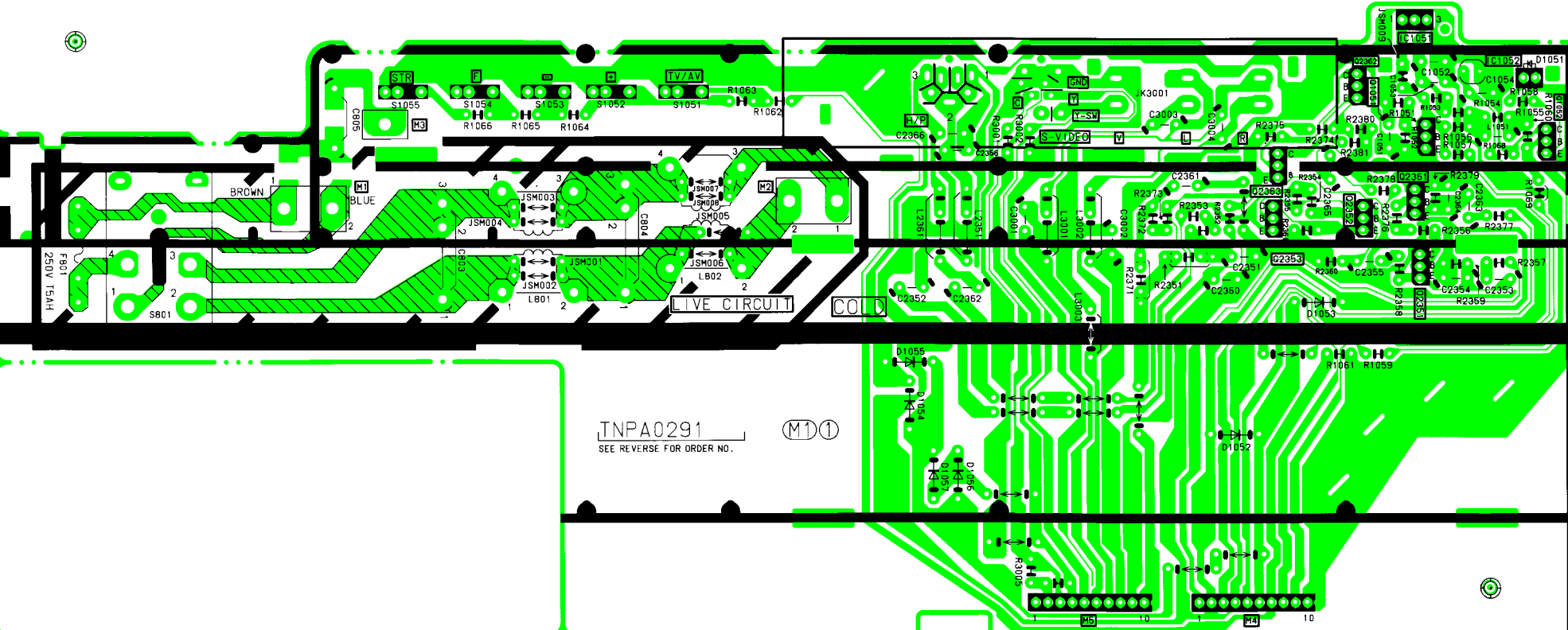

TNPA0292

SEE REVERSE FOR ORDER NO.

(2) (Y)

H.V. DANGER

(Y8)

JK381

